



Room Automation

Efficient. Individual. Easy.





Contents

| | |
|--|----|
| Integrated Room Automation | 4 |
| Improving Economic Value | 6 |
| Certificates – Excellent Quality Assured | 8 |
| The Choice Is Yours! | 10 |
| flexROOM® | 12 |
| Efficient. Individual. Easy. | 14 |
| Perfectly Coordinated | 16 |
| Variety of Technologies | 17 |
| System Distribution Box Solutions | 18 |
| The <i>WINSTA®</i> Pluggable Connection System | 19 |
| WAGO Room Automation with <i>WINSTA®</i> | 20 |
| Weather Station | 24 |
| At a Glance | 25 |
| Examples for System Distribution Boxes | 26 |
| Contact | 27 |



Integrated Room Automation

The Key to CO₂ Savings and Energy Efficiency

CO₂ Savings and Energy Efficiency

The essential tool for improving energy efficiency and exploiting potential CO₂ savings is a controlled transfer of energy within the rooms of a building. Adjusting the energy output to the room usage serves to avoid wasting energy.

Room automation solutions from WAGO are based on an integral approach that considers lighting, sun protection, and room climate systems together. They exploit synergies and provide data on the required heating and cooling loads, helping you achieve energy efficiency class A per DIN EN 15232 for your building, as well as permanently improve its economic efficiency.

Our room automation solutions are some of the most attractive options for your green building. With their high energy efficiency, flexibility and greater user comfort, they support established certification systems for sustainable buildings, such as DGNB and LEED.

Lighting

The ideal lighting control system provides ambiance and comfort while meeting the needs of energy efficiency.

Room automation from WAGO can be used for the implementation of all lighting functions: from simple switching and dimming, to presence-dependent control, to demand-based constant lighting control.

DALI multi-sensors typically handle presence detection and light intensity measurement. The lights only turn on if the room is occupied; in rooms that enjoy sunlight, only as much artificial light is added as is necessary in order to maintain the required level of illumination. In deep rooms with an uneven distribution of sunlight, multiple lighting groups are controlled separately to improve both lighting efficiency and user satisfaction.



Sun Protection

A modern sun protection controller not only reduces energy consumption, but also helps protect the environment and contributes to users' sense of wellbeing.

In addition to manual control, we also offer automatic glare protection based on the outdoor light intensity and position of the sun. Besides improving comfort by supplying the maximum amount of sunlight while avoiding glare, this approach also optimizes energy consumption.

The thermal control system reduces the energy consumption even further: In the summer months, it prevents the rooms from heating up, reducing the demand for cooling; in the cold season, sunlight provides passive heating through well-insulated windows.

Climate Control

Optimized energy consumption and maximum user comfort are the key features of modern climate control systems.

Rooms are heated or cooled to the comfort temperature setpoint – but only when occupied; unoccupied rooms are kept ready for use with the smallest amount of energy possible. When a window is open, the system avoids energy waste, while also ensuring building protection.

With time-based switch-over between different energy levels (night setback, standby mode and comfort mode), start-up optimization makes it possible to reach the desired room temperature when the switch-over occurs.

Improving Economic Value

Reducing Energy Consumption

The building sector accounts for approximately 40 % of all energy consumption and a third of CO₂ emissions in Germany. Therefore, as part of the energy transition, Germany's federal government is aiming to achieve a nearly carbon-neutral building stock by 2050. Automation technology will play an important role in reaching that goal.

By applying DIN EN 15232 "Energy Performance of Buildings – Impact of Building Automation, Controls and Building Management," substantial savings can be achieved in heating energy consumption. Without changing the building's exterior, savings of up to 30 % can be attained in office buildings, 39 % in hotels and restaurants and 14 % in hospitals.

Building automation and energy management from WAGO help reduce your building's energy consumption.

Heating Energy Demand Reduction

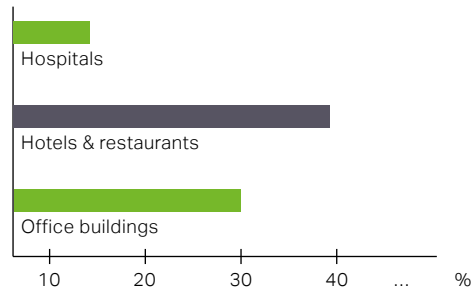

Building Automation Reduces Costs in Non-Residential Buildings

In halls and stairwells, lighting is controlled with motion and presence detectors according to the demand and the amount of sunlight.

Within rooms, the controller adjusts the amount of artificial lighting according to the detected light intensity. Here too, room occupancy determines when the lighting switches on. Usage-dependent lighting control yields potential energy savings of 40 to 50 %.

In offices, the single-room control can be used to set the heating setback, standby and operation times according to usage and occupancy profiles, as well as automatic heating/cooling shutdown when a window is opened.

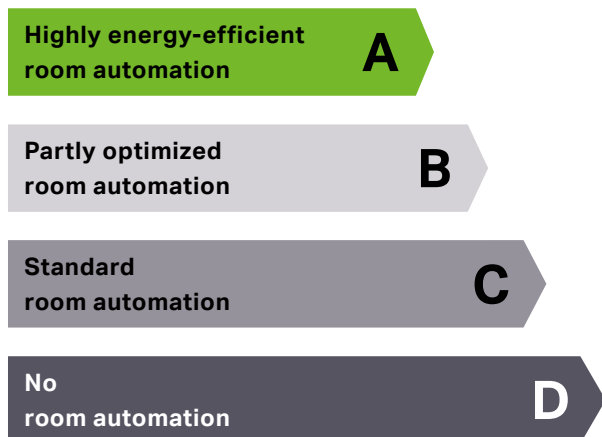

Building Automation Pays Off

Investments in building and room automation pay off. Depending on the level of investment, a payback period of just a few years can be quite realistic.

From a lifecycle cost perspective, a cost analysis should also include operating costs (energy, maintenance and service costs), which greatly exceed front-end investment costs.

Minimizing Costs

Heating, ventilation and lighting typically consume the most energy. Practical experience shows that user behavior has a particularly significant impact on energy consumption in buildings, and thus on CO₂ emissions.

At the University of Applied Sciences in Biberach, Germany, measurements were collected on behalf of ZVEI (German Electrical and Electronic Manufacturers' Association) in three classrooms over two heating periods, using different automation levels per EN 15232. Within two years, a moderate level of automation saw a 29 % reduction in energy, and a high automation level achieved a 41 % reduction.

Gas Price Increase (Industry)

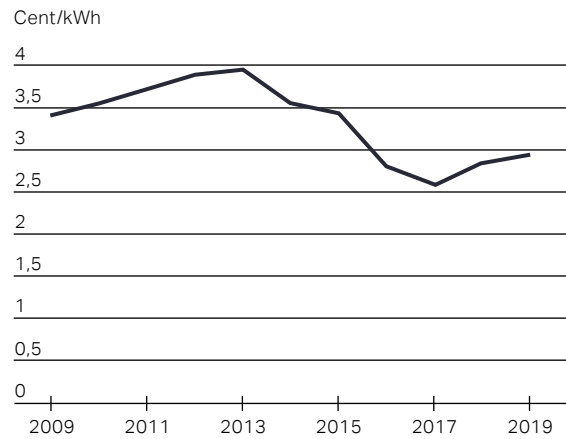

Electricity Price Increase (Industry)

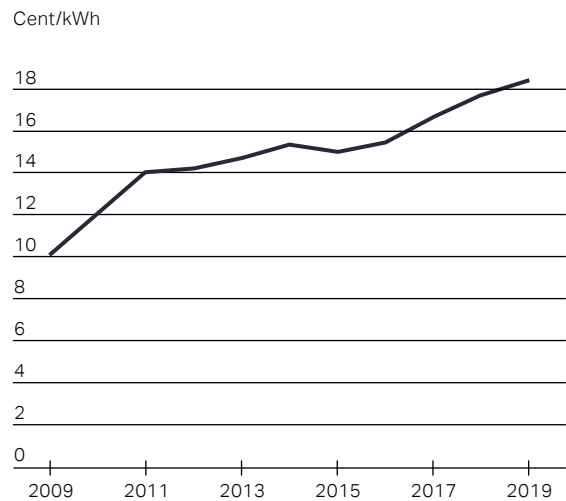

Saving energy doesn't just save money, it improves the CO₂ balance, making an important contribution to protecting our planet.

Certificates

Excellent Quality Assured

Certifications

Evidence of the growing interest in energy-efficient construction — particularly among investors — can be seen in the success of various certification systems. These methods use a points system to evaluate criteria for sustainable construction, such as environmental or functional issues, as well as the quality of the construction process.

The “German Sustainable Building Council” (DGNB) certificate also rates a building’s cost-efficiency, which is particularly interesting to investors. The DGNB issues platinum, gold, silver and bronze ratings based on the scores achieved and the degree to which requirements are met.



| Gesamterfüllungsgrad | Mindestersfüllungsgrad | Auszeichnung | |
|----------------------|------------------------|--------------|--|
| ab 35 % | — % | Bronze* | |
| ab 50 % | 35 % | Silber | |
| ab 65 % | 50 % | Gold | |
| ab 80 % | 65 % | Platin | |

*Diese Auszeichnung gilt nur für Bestandsgebäude

Source: www.dgnb.de



| Area | Criteria Group | Criteria Number | Criterion | Points | |
|---|---|-----------------|---|---------------|---------------|
| | | | | Max. Possible | Impact Factor |
| Environmental quality | Resource consumption and waste generation | 10 | Non-renewable primary energy consumption | 10 | 3 |
| | Resource consumption and waste generation | 11 | Renewable primary energy consumption | 10 | 3 |
| Economic quality | Building lifecycle costs | 16 | Building-related lifecycle costs | 9 | 3 |
| | Building value stability | 17 | Flexibility and adaptability | 10 | 2 |
| Sociofunctional and Functional Quality | Health, comfort and user-friendliness | 18 | Thermal comfort (winter) | 10 | 2 |
| | Health, comfort and user-friendliness | 19 | Thermal comfort (summer) | 10 | 2 |
| Technical Quality | Design quality of the technology | 36 | Customizability of technical systems | 10 | 2 |
| | Design quality of the technology | 42 | Easy of demolition, recycling and dismantling | 10 | 2 |
| Process Quality | Planning quality | 44 | Integral building planning | 10 | 3 |

This table contains excerpts from DGNB's evaluation criteria, in which WAGO room automation can help achieve significantly better evaluation results.

In building automation, international certification organizations such as LEED (USA), Minergie (CH), BREEAM (UK), HQE (FR), GREEN STAR (AUS) and Green Mark (Singapore) are increasingly important.

By perfectly coordinating lighting, sun protection and single-room control, **flexROOM®** significantly improves energy efficiency in your building and optimizes its evaluation results under numerous certification systems.

| LEED | Points |
|-------------------------------------|---------------|
| | Max. Possible |
| Sustainable sites | 26 |
| Water efficiency | 14 |
| Energy and atmosphere | 35 |
| Material and resources | 10 |
| Indoor environmental quality | 15 |
| Innovation and design | 6 |
| Regional priority | 4 |
| Maximum number of points | 110 |

This table contains excerpts from the LEED evaluation criteria. In the areas marked in green, significantly better results can be obtained with **flexROOM®**.

Benefits of energy-efficient building automation with **flexROOM®**:

- Compliance with current regulations and European standards
- Easy project planning and budgeting based on a segmented room concept
- Cost-effective installation and fast commissioning
- Building operator can change parameters directly during conversions

The Choice Is Yours!

Versatile Solutions for Your Project

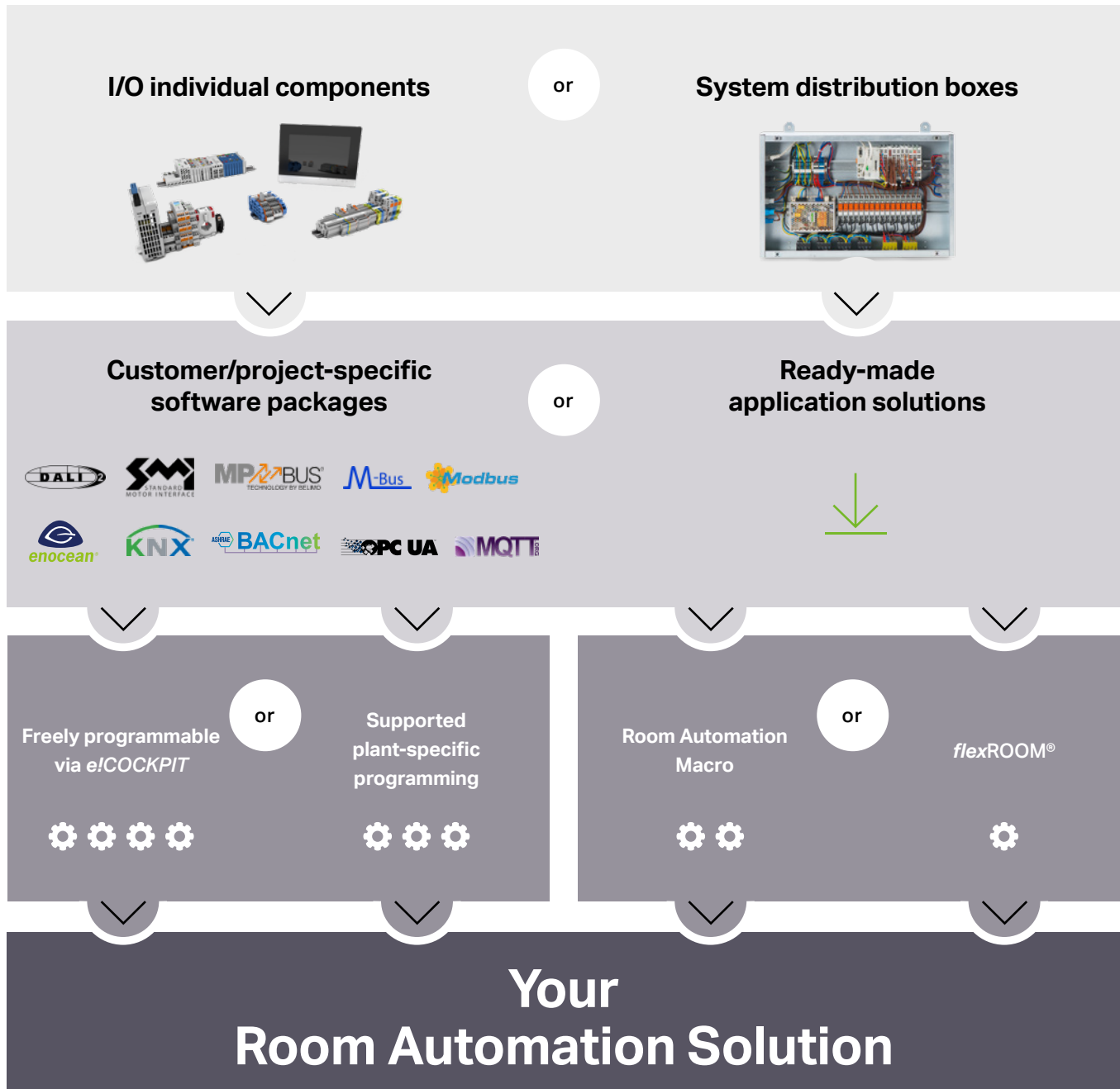

Low programming effort

High programming effort

flexROOM® – Configuration Instead of Programming!

flexROOM® is the scalable room automation solution from WAGO. It is ideal for both medium-sized and large office and administration buildings, both in new buildings and for energy upgrades.

It covers the relevant room functions for the lighting, shading and climate control systems. Thus **flexROOM®** provides the basis for achieving energy efficiency class A per EN 15232 and supports the certification of your building as a sustainable green building according to national and international systems like DGNB and LEED, for example.

And best of all: no programming necessary! It offers a Web-based graphical user interface for integrating and configuring lights, sunblinds, actuators, sensors and room control units. The concept is based on the segment as the smallest functional unit in buildings; room automation functions across all building systems are executed on the segment level. This segment-oriented concept provides flexibility throughout the building's entire lifecycle for dividing office space into rooms or open-space areas.

flexROOM® is the perfect solution for your project – but maybe you have specific additional requirements too? Project-specific adaptations or extensions are available on request.

The Room Automation Macro – the Basis for Your Custom Solution

The "Room Automation" macro provides a library and base application for easily creating scalable room automation solutions with **e!COCKPIT**. It is based on WAGO's proven **flexROOM®** solution.

All the relevant room functions of the lighting, shading and climate control systems are already available and can be customized or expanded as needed.

It also offers a Web-based graphical user interface for integrating and configuring lights, sunblinds, actuators, sensors and room control units. As with **flexROOM®**, this also provides flexibility throughout the building's entire lifecycle for dividing office space into rooms and open-space areas.

A Freely Programmable Solution with e!COCKPIT

Do you have very specific room automation project requirements that

can't be met by using **flexROOM®** or the Room Automation macro? Several libraries and application notes are available for such cases as a basis for a custom-programmed solution with **e!COCKPIT**. **e!COCKPIT** is an integrated development environment that supports every automation task, from hardware configuration, programming and simulation to visualization.



WAGO system distribution boxes contain all the required components – tested and ready for plug-in connection.



Classic: Installation of automation components in the control cabinet

flexROOM®

The Efficient Solution for Room Automation

The efficiency of room automation solutions is about more than just achieving a high energy efficiency class. These solutions should also offer easy installation and commissioning, as well as a high level of flexibility throughout the building's entire lifecycle. Depending on the level of investment, payback periods of just a few years are realistic for building automation in building projects. From a lifecycle cost perspective, a cost analysis should also include operating costs, such as energy, maintenance and service costs, which greatly exceed front-end investment costs. This is where **flexROOM®** shows its strengths.

The architecture of modern office buildings typically involves grid-based floor plans, which allow flexible positioning of walls. Even during the utilization phase, it should be possible to change rooms or open-space areas without needing to access the room automation system's wiring.

flexROOM® readily supports this approach. It provides a graphical method for segment-based assignment of field devices, such as lights, blinds and valves. Each segment contains functions for lighting and sun protection control and room temperature regulation.

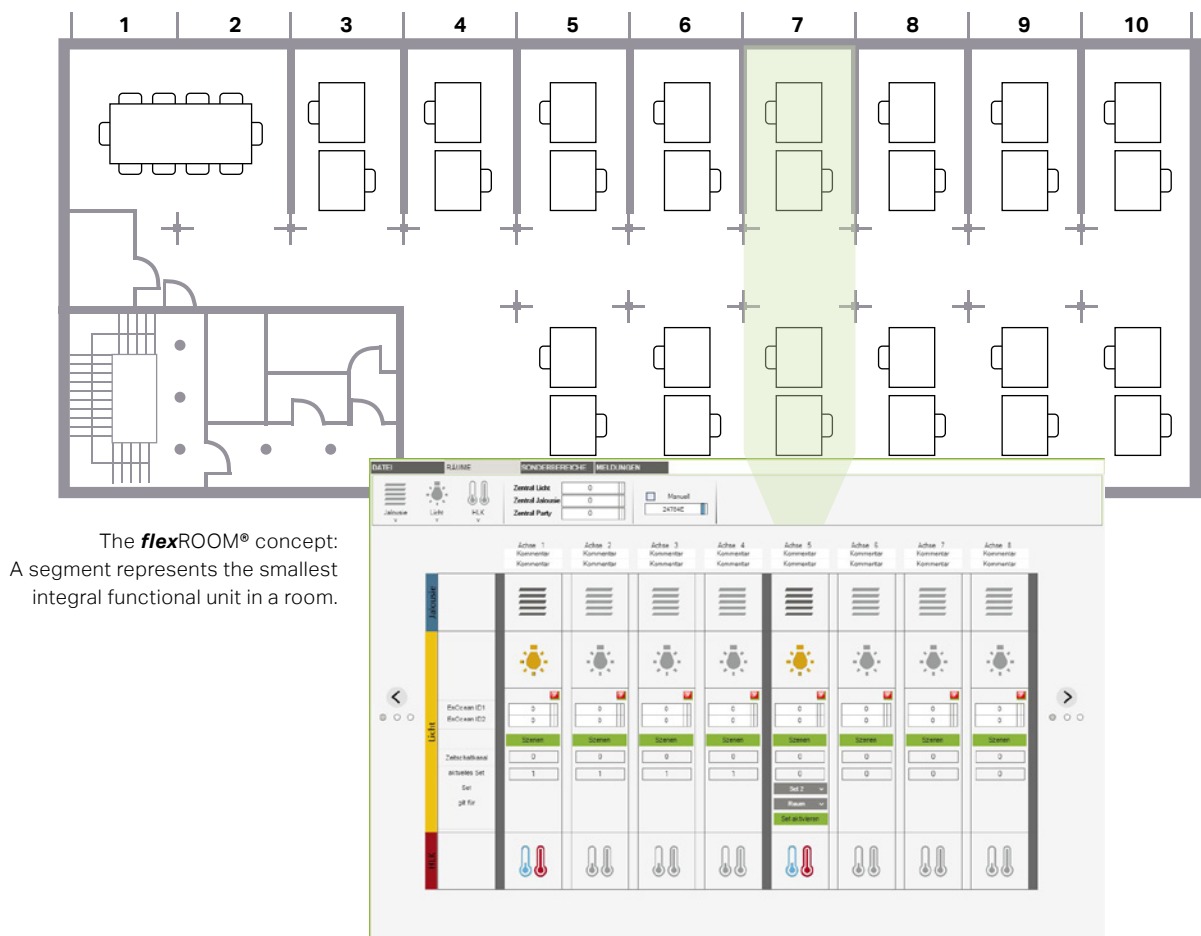

The **flexROOM®** concept:
A segment represents the smallest
integral functional unit in a room.

Pre-configured programs and pre-defined hardware significantly streamline planning and commissioning of building automation projects. Special maintenance programs make flexible building operation easier. Operators can execute conversions and room modifications themselves, eliminating external service costs. Installation, commissioning and configuration according to project specifications: **flexROOM®** combines these strengths into a standard solution.

As the smallest integral functional unit, a segment corresponds to an architectural room axis, an area or a room. Automation of special use areas such as corridors, rest-

rooms and stairwells is also included. This allows flexible use of **flexROOM®** in almost all office and administrative buildings.

flexROOM® can be wired into a building automation network via ETHERNET for automating a building area or floor or all the office units. If electrical distribution boxes are present, **flexROOM®** components can also be installed or retrofitted during renovation.

flexROOM® significantly reduces the overall costs of new installations and conversions. **flexROOM®** provides the perfect combination of high-quality hardware and intuitively tailored software!



The distribution box solution is delivered ready to operate with pre-assembled and fully wired control elements and can be installed directly in a suspended ceiling or false floor.



The well-established WAGO **WINSTA®** Pluggable Connection System allows fast, error-free connection of field devices, sensors, actuators and control devices.



The process of configuring the segments and assigning them to rooms is state-of-the-art; it's performed via Web browser and HTML5 technology.

flexROOM® significantly reduces the overall costs of new installations and conversions.

Efficient. Individual. Easy.

Perfectly Combining Hardware and Software

Using the WAGO PFC200 controller and I/O modules and interfaces you can combine as you see fit, room automation solutions from WAGO offer powerful, future-proof hardware with the quality you expect from WAGO. The integrated HTML5 Webserver allows the display of dialogs for convenient configuration, commissioning, and maintenance – all included in **flexROOM**®.

Sensors, actuators and building-specific subsystems can be integrated with the I/O modules. The DALI Multi-Master Module facilitates connection of DALI lights and additional sensors for brightness measurement or motion detection, for example. Furthermore, different room control units and push-buttons can be integrated through KNX or EnOcean® Wireless Technology. The integration of SMI sunblind drives offers numerous benefits for cabling, maintenance and diagnosis too.

Configuring – Not Programming!

flexROOM® has a Web interface for configuration. Both the commissioning technician and end user can configure the controls for each room via Web browser, regardless of the user's location and the distribution box used. Entire floor plans (setting and deleting walls) and room parameter settings, such as lighting and shading groups, can be changed using the parameter interface. No additional software is required.

All parameters are saved periodically, either directly in the controller or on a separate computer, via a secure network connection. A higher-level management station accesses **flexROOM**® parameters via the open MODBUS TCP/IP protocol. This ensures that all modifications can be implemented on-site or via the management station. Project-specific connection of BACnet® or KNX IP systems is also possible.





Display on Different Devices

- Modern Web visualization based on HTML5 also for display on tablets and smartphones
- Secure configuration via HTTPS
- Secure transmission of configuration data via SFTP

Additional Functions

In addition to room segments, automation is also possible for special-use areas like stairways, corridors and sanitary facilities. **flexROOM®** already includes support for special-use areas.

The screenshot displays the flexROOM control interface. At the top, there are tabs for 'DATEI', 'RÄUME', 'SONDERBEREICHE', and 'MELDUNGEN'. Below these are icons for 'Jalousie', 'Licht', and 'HLK'. A central control area includes 'Zentral Licht', 'Zentral Jalousie', and 'Zentral Party' with numerical values (0) and a 'Manuell' checkbox. Below this is a table with 8 columns representing 'Achse 1' through 'Achse 8', each with a 'Kommentar' field. The main control grid has three rows: 'Jalousie' (represented by horizontal line icons), 'Licht' (represented by light bulb icons), and 'HLK' (represented by thermometer icons). Each cell in the grid contains a control element, such as a slider, a 'Szenen' button, or a numerical input field. A 'Set 2' dropdown menu is visible in the 'Licht' row for Achse 5, with a 'Set aktivieren' button below it. Navigation arrows are present on the left and right sides of the grid.



Perfectly Coordinated

WAGO room automation supports an ideal work environment with pleasant room temperatures and glare-free workspaces for greater comfort. An integral approach that considers the building systems, lighting, sun protection and climate control together, as well as the provision of load signals, allows maximum energy efficiency and CO₂ savings.



Lighting Control

- Constant light control at the workplace
- "Human Centric Lighting" (HCL) for ergonomic workplace lighting
- Free definition of lighting scenes
- Temporary stairway light switching
- Automatic light for presence-dependent room lighting switching



Sun Protection

- Control of internal and external sun protection, including thermal control
- Exterior slats are positioned according to sun position or by an optional seasonal shade control
- Automatic dimming system moves slats up at dusk
- Safety functions for wind alarms and frost protection through connection of a weather station



Single-Room Control

- Presence-dependent room temperature control
- Manual setpoint adjustment
- Window monitoring – heating/cooling shuts off when windows are open
- Start-up optimization allows the room to reach the desired temperature in time for occupancy

Variety of Technologies

DALI

Digital Addressable Lighting Interface (DALI) is a technical standard for controlling lighting devices (e.g., electronic control gears), as well as presence and brightness sensors. DALI features digital communication and streamlined installation. DALI meets lighting requirements, such as switching, dimming, light grouping and status information feedback.

SMI

The Standard Motor Interface is a uniform interface for electrical sun protection and window drives. Similar to DALI, SMI also allows drives to be grouped together and status information to be returned. High positioning accuracy also makes these drives ideal for implementing sophisticated sun protection concepts.

MP-Bus

The MP-Bus controls HVAC actuators for dampers, regulator valves and air volume controls. The drives can also incorporate sensors, for example

for temperature, humidity and digital contacts, which can then also be queried via MP-Bus.

EnOcean® Radio Technology

Battery-free EnOcean® technology transmits short telegrams and requires very little energy to send radio signals. Transmitters use electrodynamic/thermoelectric energy converters or the energy from solar cells (energy-harvesting technologies).

KNX

KNX is a uniform, manufacturer-independent communication protocol for intelligently networking various building automation functions.

BACnet

“Building Automation and Control Networks” (BACnet) is a data transfer protocol for building automation. It simplifies communication between devices from different manufacturers and often provides the interface to the building management system.

Additional Technologies

Technologies such as MQTT for cloud connections, OPC-UA, Modbus TCP and RTU come standard with the WAGO PFC200 IP Controller. Support for additional protocols is possible upon request.



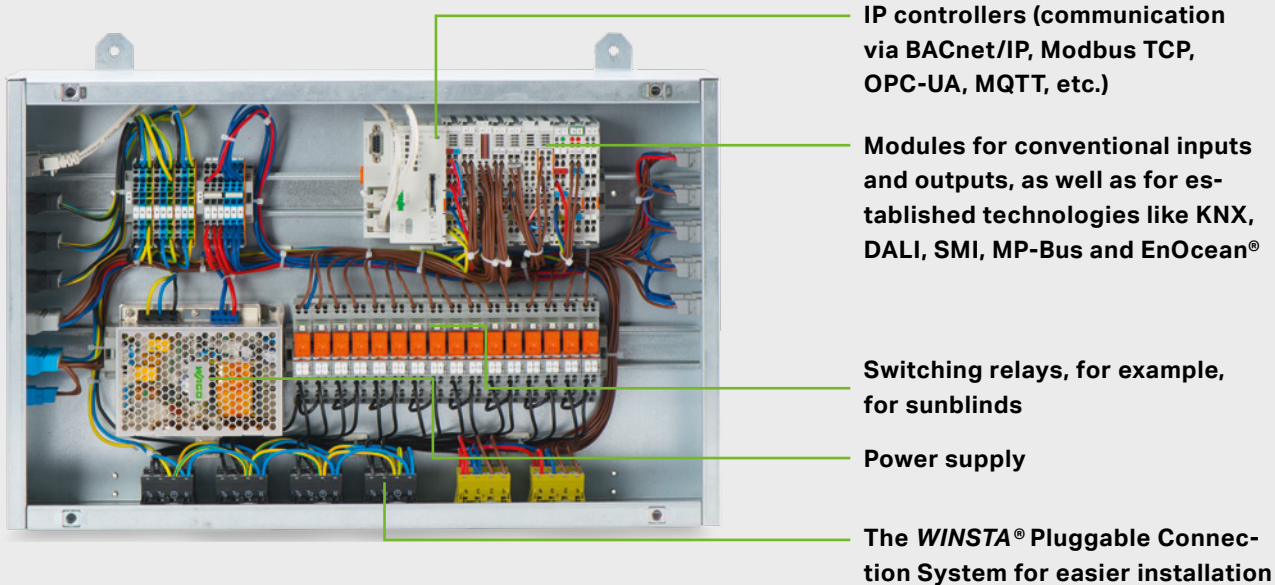

System Distribution Box Solutions

From Planning to Installation

WAGO system distribution boxes are manufactured on a project-specific basis and contain all required components, such as IP controllers and modules to accommodate field devices and subsystems. The power supply's output, as well as additional devices such as transformers, overvoltage protection and ETHERNET switches, can be specified on a project-specific basis.

Installation can be carried out in any mounting position, for instance, in false ceilings or raised floors.

The Benefits for You:

- Decentralized installation
- Shorter cable runs
- Lower fire load
- Lower space requirement in engineering rooms

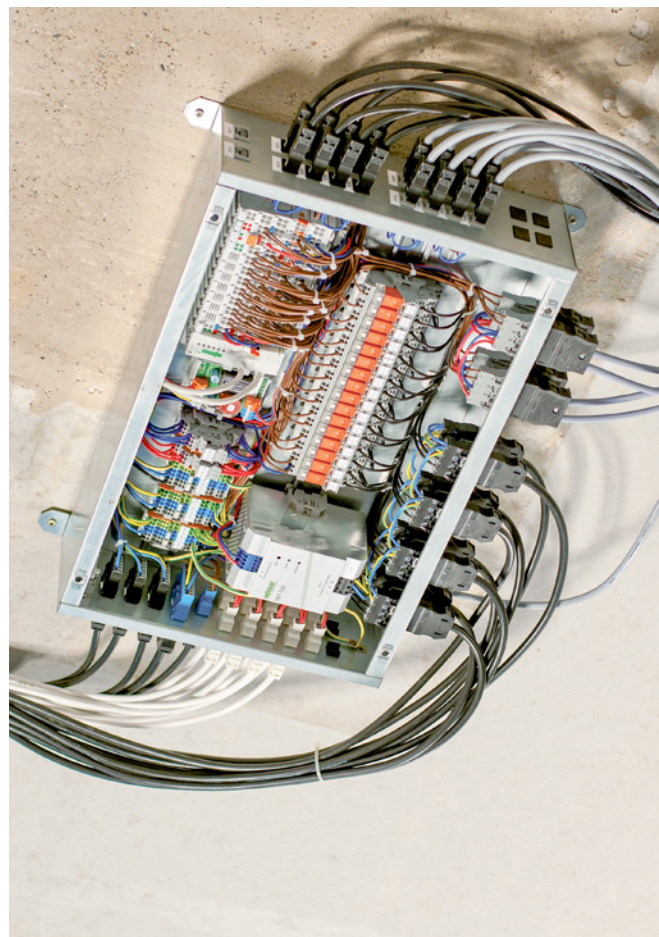

Regulations/Rules

- DIN EN 15232
- DIN EN ISO 16484
- VDI
- EnEV

Customer Requirements

- Tailored solutions
- Short payback periods

Products

- Installation and rail-mount terminal blocks
- The *WINSTA*® Pluggable Connection System
- Relays
- Power supply
- ETHERNET switches
- WAGO I/O System



Energy efficiency

System distribution boxes



Lighting



Sun Protection



Climate Control

The *WINSTA*® Pluggable Connection System

For Fast, Error-Free Installation



The *WINSTA*® Pluggable Connection System is perfectly tailored to the strict requirements of building installation. The modular, pluggable installation system consists of cable assemblies and standard components. Installation is planned in advance, and the required components and cables are specified and ordered. The electrical components of a project – lights, sockets or climate control systems – can be procured from *WINSTA*® system partners with plugs already integrated, or equipped with the right *WINSTA*® pluggable connectors for any job site. At the job site, everything can then be plugged in quickly and reliably.



The Benefits for You:

- Option of cable pre-assembly
- Fast, easy connection
- Safe, maintenance-free connection technology
- Minimum installation time
- Waste-free installation
- Complete connector set for self-assembly also available

WAGO Room Automation with WINSTA®

Segment 1 ...

Segment 8

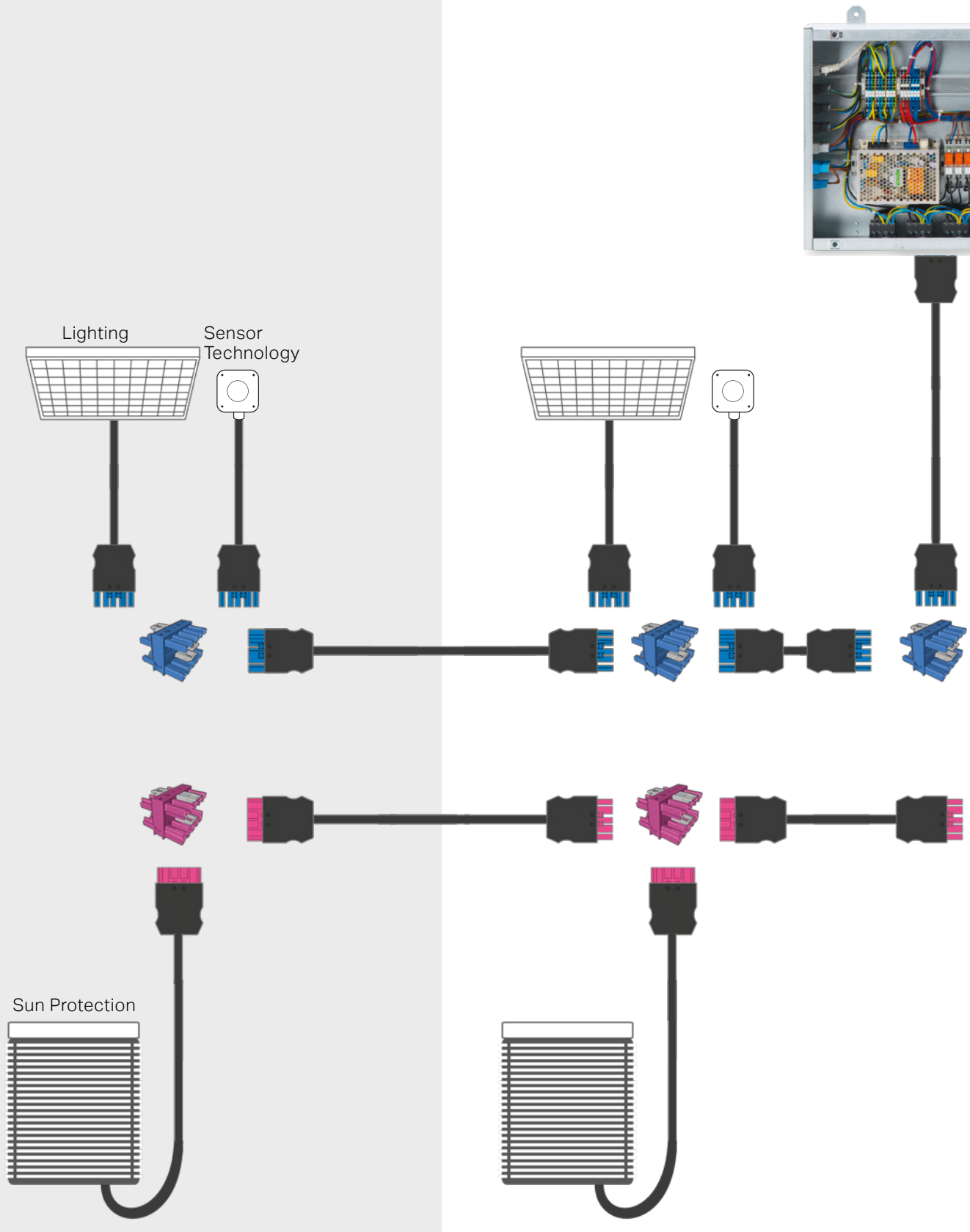

Segment 9

... Segment 16

Sun protection with SMI and lighting with DALI
(including sensors)

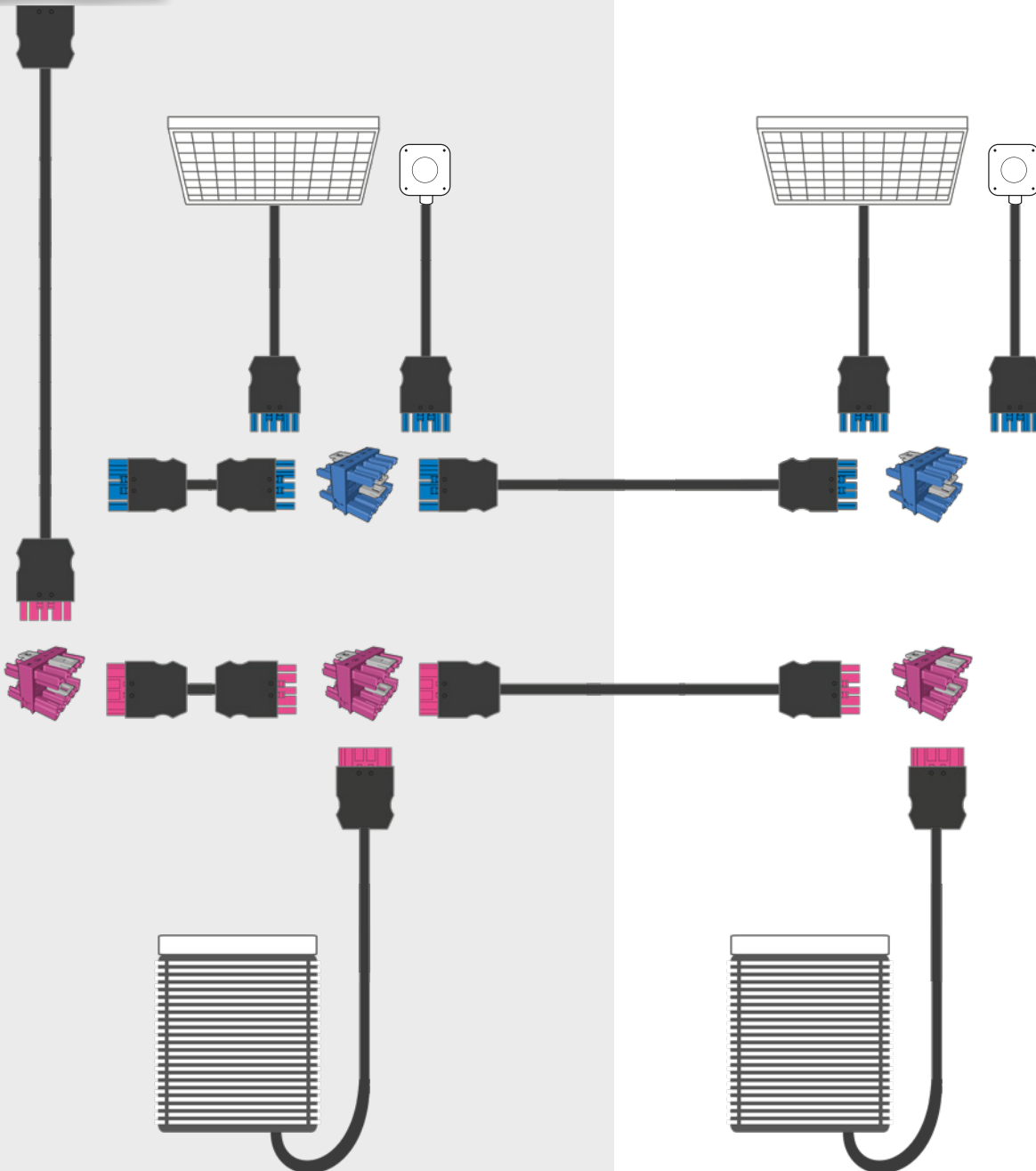
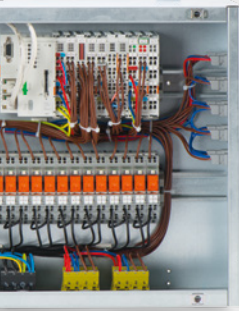

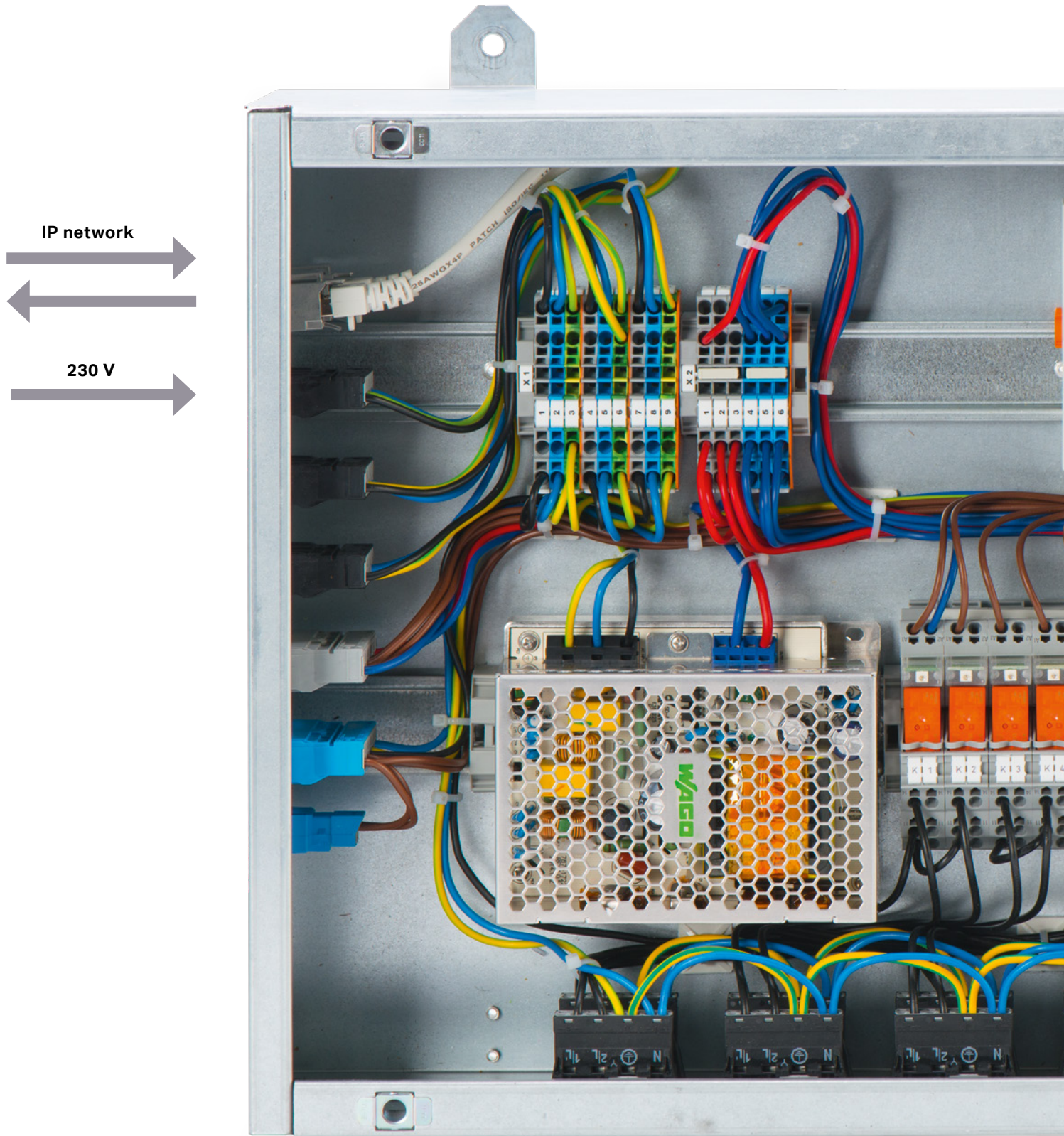



Building management system (BMS/GLT)
Display and control devices
Cloud platforms
Weather Station
Other system distribution boxes/controllers

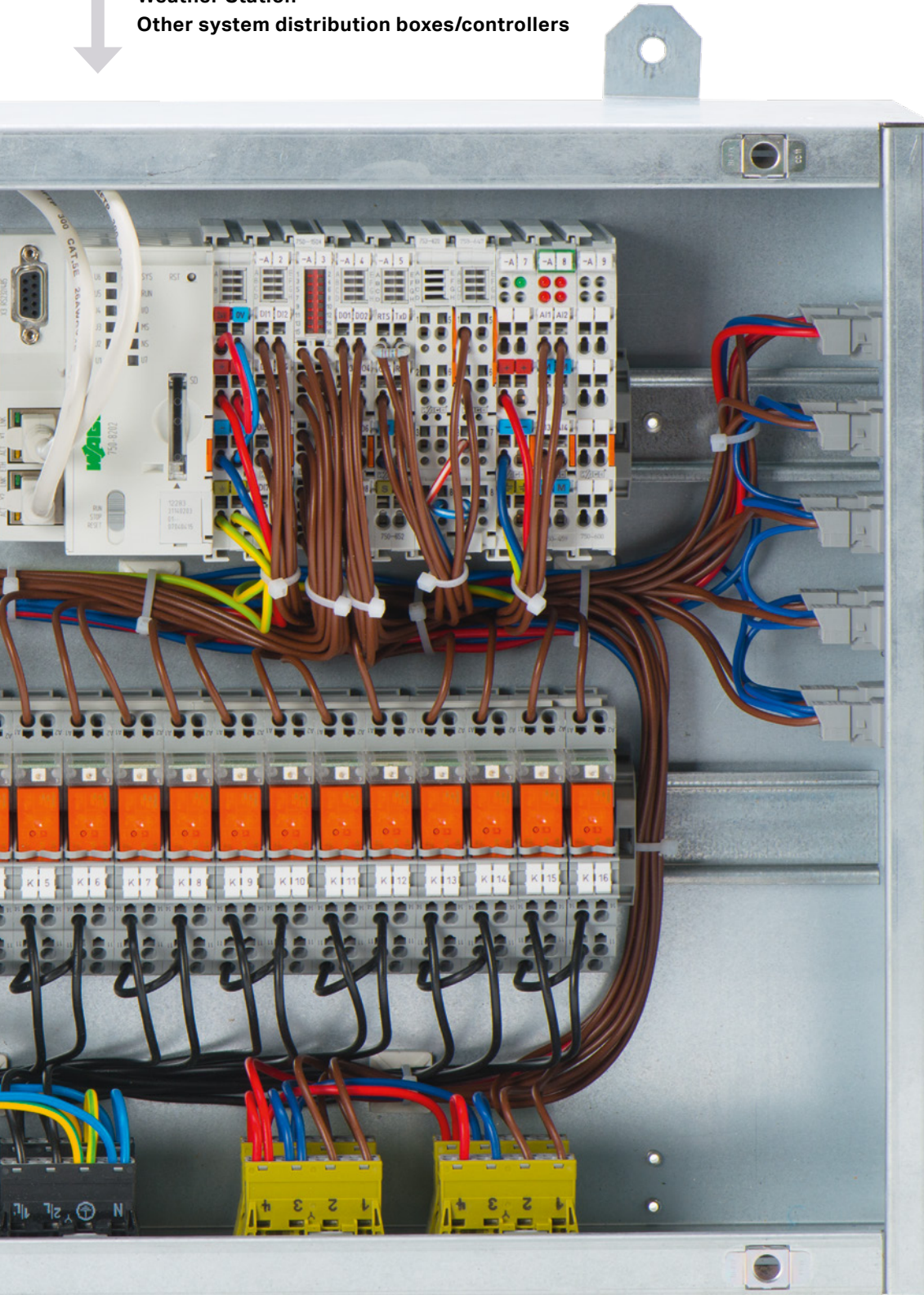

Lighting



Sun Protection



Climate Control



Weather Station

Weather sensors from different manufacturers can be integrated as digital inputs or analog inputs (0 ... 10 V or 4 ... 20 mA) or via RS-485. WAGO Weather Station makes all the relevant sensor data, such as temperature, precipitation, wind speed and light intensity, available for further processing and display in a visualization or a management system.

It also features central functions like weather protection, automated glare protection and timer programs. The slat tracking based on the sun's position allows the maximum amount of sunlight into rooms while avoiding glare. For this purpose, Weather Station calculates the exact position of the sun, records its intensity with the help of connected light intensity sensors and periodically adjusts the position of the blinds.

Shading correction also optimizes the supply of sunlight. It takes the

shading caused by surrounding buildings into account according to an existing shading analysis for the specific property. This is so only the blinds that are actually in the sun are adjusted to the sun's position. Blinds of the shaded windows can be raised, or their slats can be set in a horizontal position, to improve the supply of sunlight in the room, increasing workplace comfort.

Typical weather protection functions move all the building's shades into a safe position and lock them there when there is a risk of damage; in contrast, the "Dynamic Wind Monitoring" function allows selective weather protection. In the presence of strong winds, it only protects the shades that are actually at risk of damage according to an existing wind analysis for the specific property. With this approach, slat tracking (which ensures glare-free workspaces) and automatic thermal control (which reduces the

cooling load) can remain active for the other shades, for example. That way, they can continue to maximize comfort and optimize energy efficiency and CO₂ savings. Taking local wind profiles into account also provides better protection against damage.

The required components can be supplied either in a system distribution box or separately for installation in a control cabinet. Of course, the sensors and the power supply can also be connected with our proven *WINSTA*[®] Pluggable Connection System.

At a Glance

Room automation solutions from WAGO are ideal for use in non-residential/commercial buildings. An integral approach that considers the lighting, sun protection and climate control together is the perfect basis for achieving energy efficiency class A per DIN EN 15232 and for sustainably improving the economic viability of your building. The required automation hardware can be supplied either in project-specific system distribution boxes or separately for installation in control cabinets.

flexROOM® is the standard solution for your room automation. IP con-

trollers already provide the automation functionality, while offering a Web-based user interface for commissioning and maintenance, as well as for easy reconfiguration and conversion of rooms during building operation, for instance by facility management. This eliminates the hassle of installing and updating software on your PC; all that is required is an up-to-date standard Web browser.

The "Room Automation Macro" allows you to easily create a scalable room automation solution with **e!COCKPIT**. All relevant room func-

tions and configuration dialogs are already set up and can be modified and expanded. It is based on WAGO's proven **flexROOM®** solution. This makes it easy to reconfigure and convert rooms during ongoing operations via Web browser at any time throughout the building's lifecycle.

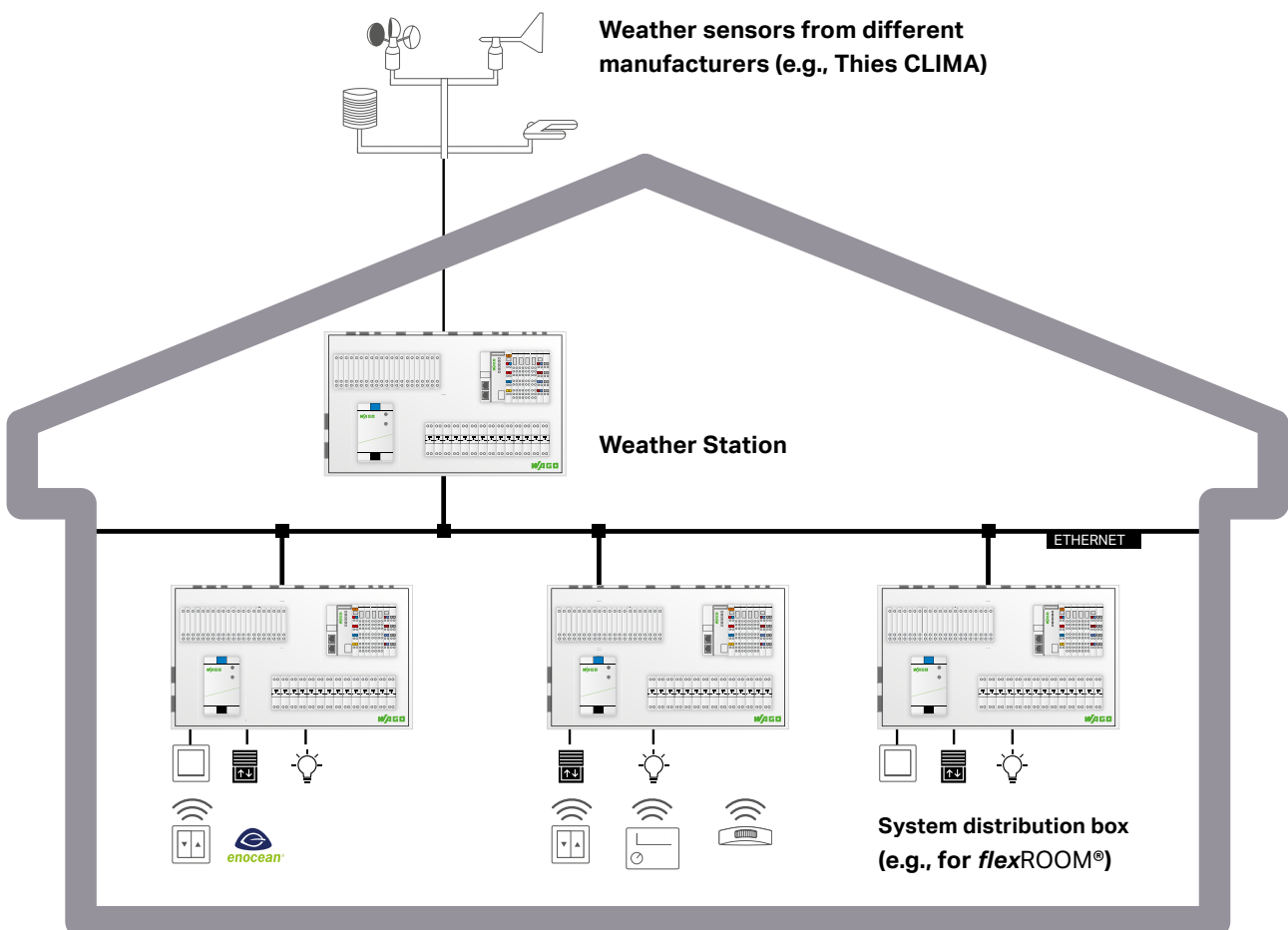

Examples for System Distribution Boxes

| Number of Room Segments | Subsystems* | | | | Office Areas (Segments) | | | | | Special-Use Areas | | | | | |
|---------------------------------|-------------|-----|----------|-----|------------------------------|---------------------|-----------------|----------------------|-----------------|-------------------|-------------------|---------------------|-------------------|-------------------------|-----------------|
| | DALI | SMI | EnOcean® | KNX | Inputs | | Outputs | | | Inputs | | | Outputs | | |
| | | | | | Multi-Sensors (Conventional) | Dew Point Detectors | Lighting (DALI) | Sun Protection (SMI) | Heating/Cooling | Light Switches | Sunblind Switches | Dew Point Detectors | Lighting (Relays) | Sun Protection (Relays) | Heating/Cooling |
| 8 segments | x | x | x | x | x | 8 | x | x | 8 | - | - | - | - | - | - |
| 8 segments and 4 special areas | x | x | x | x | x | 8 | x | x | 8 | 8 | 4 | 4 | 4 | 4 | 4 |
| 16 segments | x | x | x | x | x | 16 | x | x | 16 | - | - | - | - | - | - |
| 16 segments and 4 special areas | x | x | x | x | x | 16 | x | x | 16 | 8 | 4 | 4 | 4 | 4 | 4 |
| 24 segments | x | x | x | x | x | 24 | x | x | 24 | - | - | - | - | - | - |
| 24 segments and 8 special areas | x | x | x | x | x | 24 | x | x | 24 | 16 | 8 | 8 | 8 | 8 | 8 |

For more information, please visit us at <https://www.wago.com/us/room-automation> or contact us directly.

Components

| Components | Item Number | Description |
|--|--------------------|---|
| Application | | |
| License for flexROOM® Application | 2759-2110/261-1000 | Application available at www.wago.com/us/room-automation |
| License for Room Automation Macro Library | 2759-244/211-1000 | Library and application note available at www.wago.com/us/room-automation |
| License for Weather Station Application | 2759-241/261-1000 | Application available at www.wago.com/us/room-automation |
| Additional Licenses: Shading Correction | 2759-242/261-1000 | |
| Dynamic Wind Monitoring | 2759-243/261-1000 | |
| Controllers | | |
| PFC200 G2 2ETH RS Controller | 750-8212 | Powerful IP controller, expandable with I/O modules and communication modules |
| RS-232/RS-485 Serial Interface Module | 750-652 | For connection to devices with a serial interface (e.g., weather sensors, EnOcean® receivers) |
| End Module | 750-600 | Module for proper termination of the I/O bus |
| Power Supply, 24 VDC, 2.5 A | 787-1012 | Supplies both controllers and modules |
| I/O Modules | | |
| Digital Input Modules | 75x-4xx, 75x-14xx | For connection to push-buttons, switches and sensors with a potential-free contact |
| Digital Output Modules | 75x-5xx, 75x-15xx | For connection to digital actuators and relays |
| Relay Module | 788-354 | For lamp loads |
| Relay Module | 788-304 | For sunblind actuators |
| Analog Input Modules | 75x-4xx | For connection to sensors with analog output signal (0 ... 10 V) |
| Analog Output Modules | 750-5xx | For connection to actuators with analog control signal (0 ... 10 V) |
| DALI | | |
| DALI Multi-Master Module | 753-647 | In addition to 64 DALI actuators (ECGs), a DALI-2-certified module supports up to 16 DALI multi-sensors (max. 64 sensor addresses). |

| | | |
|---|-----------------|---|
| DALI Multi-Master DC/DC Converter | 753-620 | Converter (24 VDC/18 VDC) to power one DALI Multi-Master Module |
| Power Supply for DALI Multi-Master | 787-1007 | Supplies a maximum of five DALI Multi-Master Modules |
| DALI-2-Certified Sensors and Other DALI Sensors | | DALI compatibility list available at www.wago.com/us/room-automation |
| SMI | | |
| SMI Master | 753-1630 | For connection to a maximum of 16 SMI drives (230 VAC) |
| SMI Master LoVo | 753-1631 | For connection of a maximum of 16 SMI low-voltage drives (24 VDC) |
| MP-Bus | | |
| M-Bus Master Module | 750-643 | For connection of valve and damper actuators with MP-Bus interface |
| EnOcean® | | |
| EnOcean® Receiver/Transmitter | 2852-7101 | Receiver/transmitter with serial interface for EnOcean® switches, sensors and room control units |
| EnOcean® Repeater | 2852-7102 | Improves coverage – further information on planning can be found at www.enocean.com |
| EnOcean® Light Push-Button (2 Channels) | 758-940/001-000 | For one light circuit |
| EnOcean® Light Push-Button (4 Channels) | 758-940/003-000 | For two light circuits |
| EnOcean® Sunblind Button (2 Channels) | 758-940/002-000 | For operation of one blind |
| EnOcean® Sunblind Button (4 Channels) | 758-940/004-000 | For two blinds |
| EnOcean® Room Control Unit, SR04 P | 2852-7112 | With integrated temperature sensor and rotary wheel for setpoint correction, for surface mounting |
| EnOcean® Room Control Unit, with LCD, SR06-LCD | 2852-7113 | With integrated temperature sensor and buttons for setpoint correction, for 55 x 55 switch programs |
| KNX | | |
| KNX TP1 Module | 753-646 | Connects to KNX TP1 components (e.g., room control units and buttons) |
| M-Bus | | |
| M-Bus Master Module | 753-649 | For connecting energy meters with an M-Bus interface |

Contact

Project Support

Our technical sales support offers you consultation and project planning services for designing building automation and installation. Our experienced team of professionals will be happy to help you implement your projects.

Planning and Project Design

- Conceptual implementation
- Network planning
- Application design
- Component selection
- Quote generation

We Support You with:

- Construction project planning advice from experts with years of project experience
- Customizing solutions to ensure the technical and commercial success of large projects
- Technical support for implementing building projects

WAGO Contact Technology GmbH & Co KG

Germany
Product Support
Phone: +49 (571) 887 44555
Email: support.de@wago.com

Note: For more information, please visit our website: <https://www.wago.com/us/room-automation>

WAGO Contact Technology GmbH & Co KG

Postfach 2880 · D-32385 Minden
Hansastraße 27 · D-32423 Minden

info@wago.com
www.wago.com

| | |
|--------------|---------------------|
| Headquarters | 0571/ 887 - 0 |
| Sales | 0571/ 887 - 44 222 |
| Orders | 0571/ 887 - 44 333 |
| Fax: | 0571/ 887 - 844 169 |

WAGO is a registered trademark of WAGO Verwaltungsgesellschaft mbH.

“Copyright – WAGO Kontakttechnik GmbH & Co. KG – All rights reserved. The content and structure of the WAGO websites, catalogs, videos and other WAGO media are subject to copyright. Distribution or modification of the contents of these pages and videos is prohibited. Furthermore, the content may neither be copied nor made available to third parties for commercial purposes. Also subject to copyright are the images and videos that were made available to WAGO Kontakttechnik GmbH & Co. KG by third parties.”