



Contents

Product Overview	4
WAGO Energy Management	6
Selection Guide: Measurement Technology	10
Energy Meters (MID)	12
3-Phase Power Measurement Modules, 750 Series	16
3-Phase Power Measurement Modules, 2857 Series	18
Current/Voltage Signal Conditioners and Power Measurement Modules	20
Selection Guide: Current Transformers	24
Split-Core Current Transformers	26
Plug-In Current Transformers and Plug-in current transformers for billing purposes with CAGE CLAMP®	
Connection Technology	30
Plug-In Current Transformers with <i>picoMAX</i> ®	
Pluggable Connectors	34
Rogowski Coils	36
Current and Voltage Taps	38
Voltage Taps	40
Line Length Calculation for Current Transformers	42
Terminal Block Assemblies for Current Transformers and Voltage Taps	44
Intelligent Current Sensors	46



Energy Meters (MID)

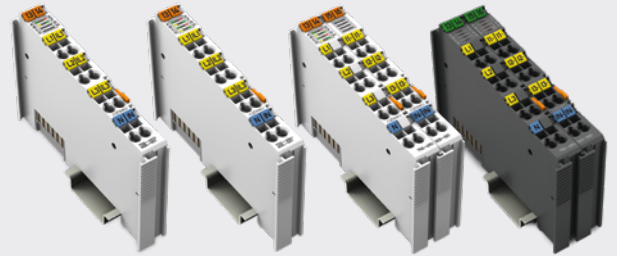

3-Phase Power Measurement Modules

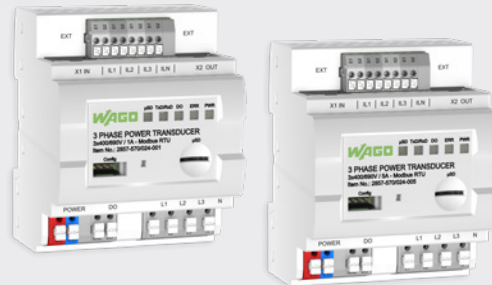

3-Phase Power Measurement Modules, 2857 Series

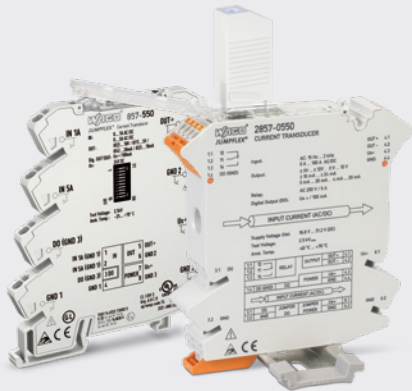

Current/Voltage Signal Conditioners and Power Measurement Modules



Split-Core Current Transformers

WAGO Current and Energy Measurement Technology

Product Overview

The demand for systematic energy management has never been greater because it can significantly reduce escalating energy costs. The use of standardized and cost-effective automation technology is simplifying what was previously an exhausting puzzle of highly varied technological components.

Many energy management projects have shown that energy savings of 30% or more are possible, depending on the operating conditions.

When this type of project is started, however, only the total energy costs are initially known. There is a lack of detailed information about the amount of energy used at specific points and exactly where energy can be saved. Therefore, improvement processes begin with the systematic recording, analysis and evaluation of an organization's energy consumption.



Plug-In Current Transformers with CAGE CLAMP®



Plug-In Current Transformers with *picoMAX*® Pluggable Connectors



Rogowski Coils



Current and Voltage Taps



Voltage Taps

Energy Meters (MID), 879 Series

Energy meters measure active and reactive energy, mains frequency and current, voltage and power in all phases.

3-Phase Power Measurement Modules, 750 Series

3-Phase Power Measurement Modules for the WAGO I/O System evaluate voltage and current, as well as power and energy consumption in three-phase networks.

3-Phase Power Measurement Modules, 2857 Series

With the 3-Phase Power Measurement Module in a DIN-rail-mount enclosure, WAGO offers the ideal solution to measure currents and voltages in a three-phase supply network – at a distance from the control level.

Current and Voltage Signal Conditioners and Power Measurement Modules, 857 and 2857 Series

Measure DC and AC currents or DC and AC voltages.

Current Transformers, 855 Series

To convert AC currents, consider:

- Split-core current transformers
- Plug-in current transformers with CAGE CLAMP®
- Plug-in current transformers with *picoMAX*® pluggable connectors

Rogowski Coils, 855 Series

Convert AC currents up to 4000 A.

Current and Voltage Taps, 855 Series

Combining a current transformer and voltage tap, this ingenious solution can be quickly and easily mounted in the jumper slot of WAGO's 285 Series 2-Conductor Through Terminal Blocks

Voltage Taps, 855 Series

Safely tap the measurement voltage.

- For insulated conductors
- For busbars

WAGO Energy Data Management – the Right Solution for Every Step

With Our State-of-the-Art Energy Data Collection

Transparency Pays Off

Synchronized electricity and energy measurement solutions allow comprehensive recording of consumption data, providing a basis for obtaining relevant efficiency figures. This transparency is essential for discovering potential savings and, with appropriate measures, trimming costs considerably. Cost reduction is also particularly important for large-scale consumers, such as the press line or body assembly area in an auto plant.

Measuring – Systematically Record Energy Consumption

Anywhere high currents must be measured and processed, plug-in current transformers are always the first choice. If existing systems need to be retrofitted, you can save time by using Rogowski coils to avoid disassembling cables or interrupting processes.

Energy meters record values for active and reactive energy and mains frequency, as well as current, voltage and power for all phases. They are MID-compliant and, through simple data acquisition, make it much easier to allocate energy consumption to individual tenants or consumption points. The consumption data is provided via M-Bus or Modbus® and can be passed directly to WAGO Energy Data Management for evaluation. Uncovered insight helps pinpoint sources of waste to reduce unwanted energy consumption and increase energy efficiency.

CONVERSION



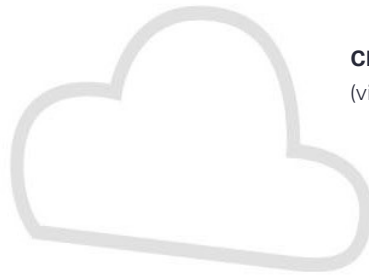

Cloud Connectivity

(via MQTT)

STORAGE



PARAMETER SETTING
VISUALIZATION
EVALUATION



RECORDING

Evaluating – Identifying and Planning Energy Use

A trio of standard 3-Phase Power Measurement Modules from the WAGO I/O System 750 is available for recording and evaluating all relevant metrics from a three-phase supply network. A variant engineered for extreme conditions (XTR) and harsh applications is also available. This variety allows comprehensive network analysis and optimal control of the power supply for machine drives, helping prevent damage, machine failure and downtime.

Parameterization and Visualization

Software solutions for the WAGO I/O System and WAGO Signal Conditioners simplify parameterization and visualization with the new WAGO Energy Data Management Application.

Cloud Connectivity

The MQTT software extension for the PFC100 and PFC200 Controllers allows data to be easily transmitted from the field level to the cloud. You can decide whether the controller sends the data to Microsoft Azure, Amazon Web Services or IBM Bluemix.

MEASUREMENT



A Measurement System with Added Value

Easily Record, Visualize and Analyze Energy Data

With our energy data management solution, you can record and visualize your measurement data for different media and influential variables (as well as the key figures calculated from it) in no time. Continuous acquisition and monitoring form the basis for resource-efficient energy usage – the environment will thank you, and your operating costs will be minimized. As an added bonus, conformity with DIN EN 50001 for the energy evaluation is part of the package.

WAGO Energy Data Management consists of Web-based application software combined with a modular control system.

It records measurement data for different media and influential variables for energy monitoring and processes it for further analysis, archiving and reporting. The software automatically detects different signals from the connected meters and sensors, and they can be made available to additional energy analysis tools via simple parameter settings. Optional modern dashboards can display efficiency gains in a clear, comprehensible, device-independent manner. This insight guides you in optimizing energy consumption in your building or production facility – either locally or across the globe.

NEW!
Integration of MID-Compliant
879 Series Energy Meters into
Energy Data Management

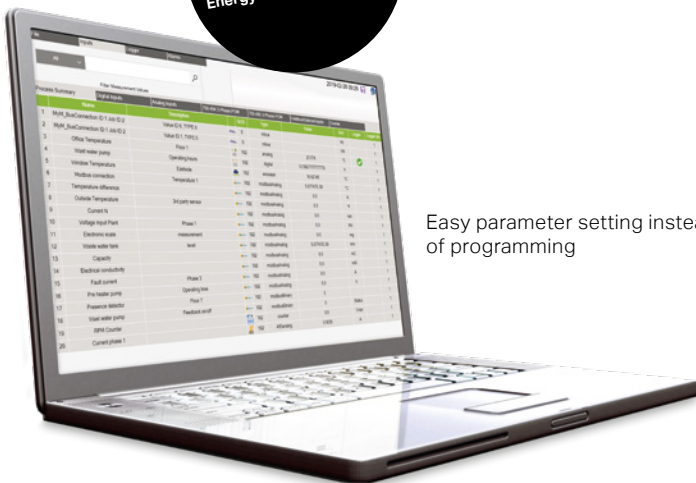

Easy parameter setting instead of programming

Your Benefits:

- Ready to go in a few easy steps
- No programming experience required
- Integrated cloud connectivity



Touch Panel 600

Controller PFC200

Find out more:
www.wago.com/energy-management

Precisely Tailored Hardware

Modular energy and process data collection, management and visualization

Evaluation

A convenient solution for evaluating energy data and deriving efficiency plans

Setting Parameters instead of Programming

Easy input parameterization via Web visualization; no programming experience required

Retrofitting Existing Systems

Connect existing sensors to the WAGO I/O-System – integration into existing systems maximizes both flexibility and your return on investment

Cybersecurity

Functions integrated into the controller, such as OpenVPN, IPsec or a firewall, protect the transmission path for securely storing your data in the cloud

System Scope at a Glance

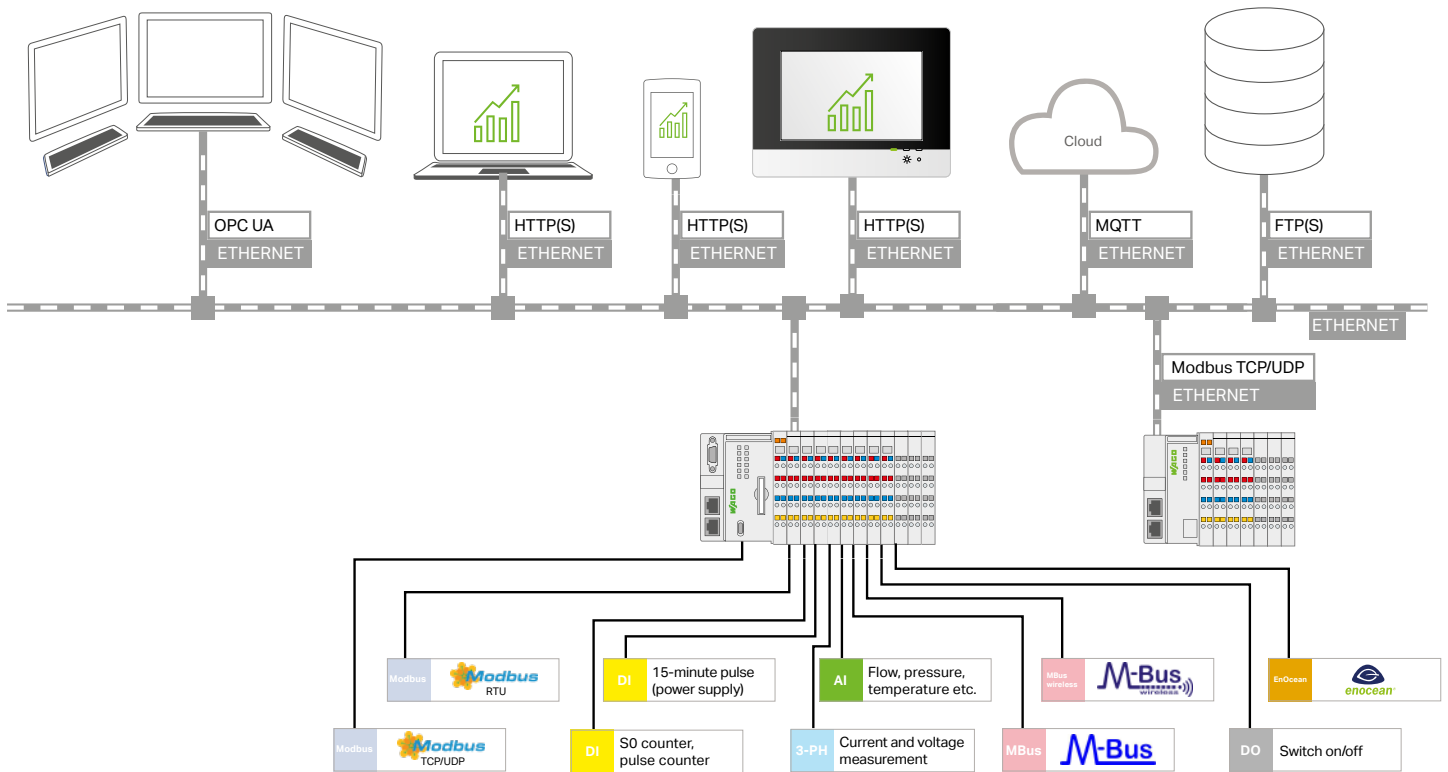

Energy data collection with the MID-compliant energy meters via Modbus RTU and M-Bus, as well as two S0 interfaces and Bluetooth®:

It is possible to record energy values in a decentralized fashion, at a distance from the control level, using MID-compliant energy

meters that are suitable for billing. Values are then transmitted to a higher control level via Modbus RTU/M-Bus or S0.

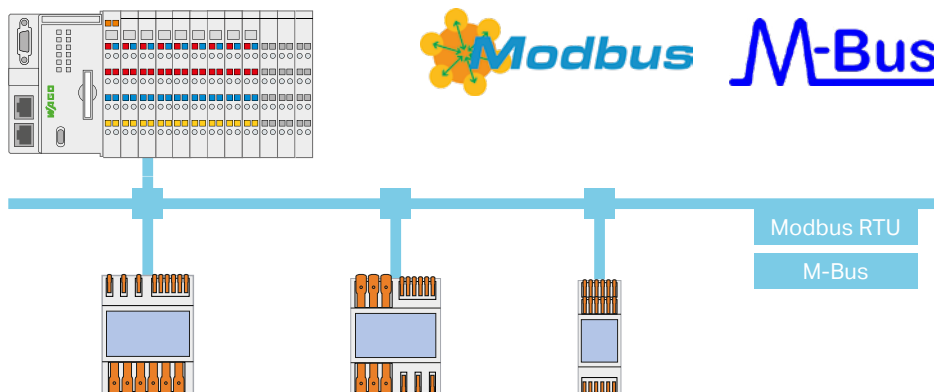

Selection Guide: WAGO Measurement Technology

The Right Solution for Every Application

Measurement Devices 879, 750, 857 and 2857 Series	Energy Meters			3-Phase Power Measurement		
Illustration						
Application	Measurement, indication, billing (MID approval)			Measurement and evaluation with the WAGO I/O System		
Input voltage	3 x 230 / 400 VAC	3 x 230 / 400 VAC	3 x 230 / 400 VAC	3~ 277 / 480 VAC 2 x 277 VDC	3~ 277 / 480 VAC 2 x 277 VDC	3~ 400 / 690 VAC
Input current	Direct: 65 A	Direct: 65 A	1 A / 5 A*	1 A (750-493)* 5 A (750-493/ 000-001)*	1 A (750-494)* 5 A (750-494/ 000-001)*	1 A (750-495)* 5 A (750-495/ 000-001)* to 4000 A (750- 495/000-002)**
Output	Modbus®, M-Bus and 2 S0 interfaces			Process data in the WAGO I/O System		
Energy consumption	x	x	x	x	x	x
Active, apparent and reactive energy/power	x	x	x	x	x	x
Phase position	x	x	x	x	x	x
Rotary field detection	x	x	x		x	x
Power factor	x	x	x	(x)	x	x
Four-quadrant op- eration (inductive, capacitive, consumer, generator)	x	x	x		x	x
Neutral conductor measurement						x
Specialty function	Display and <i>Bluetooth</i> ®					
Other product variants					Extended tempera- ture range: -20 ... +60 °C: 750-494/025-000 (1 A), 750-494/025-001 (5 A)	750 XTR: 750-495/040-000 (1 A), 750-495/040-001 (5 A), 750-495/040-002 (Rogowski Coil)
Housing width	72 mm (4TE)	72 mm (4TE)	35 mm (2TE)	12 mm	12 mm	24 mm
Item number	879-3000	879-3020	879-3040	See information on current	See information on current	See information on current
EAN number				4055143374385 4055143374422	4050821548232 4050821548249	4050821548256 4050821548270 4050821841593
Note	Plug-in current transformers, split see "Selection Guide:"					

* Only with a current transformer

** Only with a Rogowski coil

Modules		3-Phase Power Measurement Module	1-Phase Power Measurement Module	Through-Hole Current Signal Conditioner	Current Signal Conditioner	Voltage Signal Conditioner
						
AC/DC current measurement via external shunt	Measurement in the medium-voltage range	Measurement, evaluation and recording at a distance from the control level	Measurement, isolation, amplification, filtering, conversion			
3~ 277 / 480 VAC 2 x 277 VDC	3~ 20 kV, exclusively via sensors per IEC 61869-7	3~ 400 / 690 VAC	500 VAC/DC			300 VAC/DC
Depending on external shunt (50 ... 300 mV)	300 A, exclusively via sensors per IEC 61869-8	1 A (2857-570/024-001)* 5 A (2857-570/024-005)* To 4000 A (2857-570/024-000)**	Direct: max. 8 AAC/DC	Via hall sensor: max. 100 AAC/DC	Direct: max. 6 AAC/DC	
		RS-485 Serial Interface (Modbus-RTU) Digital output	Analog output module (± 10 V / ± 20 mA) Digital output Relay output: (max. 6 A)		Analog output module (± 10 V / ± 20 mA) Digital output	
x	x	x	x			
x	x	x	x			
x	x	x	x			
x	x	x				
x	x	x				
		x				
		microSD slot	Digital output as S0 interface			
12 mm	24 mm	72 mm (4TE)	22.5 mm	22.5 mm	6 mm	6 mm
750-494/000-005	750-495/040-010	See information on current	2857-569	2857-550	857-551	857-560
4055143361057	4055144024395	4055143827539 4055143287461 4055143829199	4055143907323	4050821676997	4050821476917	4055143481571

-core current transformers, Rogowski coils, voltage taps –
WAGO Current Transformers," pages 24 ... 25

WAGO Energy Meters (MID)

Compact Energy Meters with Large Displays

Comprehensive energy measurement is necessary for optimizing energy consumption. WAGO's portfolio now has new energy meters that offer numerous benefits.

Your Benefits:

- Record of values for active and reactive energy and mains frequency, as well as current, voltage and power for all phases
- Professional communication thanks to the M-Bus and Modbus® interface and two S0 pulse outputs
- Intuitive configuration through touch-sensitive controls and configuration app via *Bluetooth*®
- Full transparency with an illuminated full-format display
- Time savings at every level thanks to Push-in CAGE CLAMP® and levers
- Slim design conserves valuable control cabinet space



Energy meter, transformer connection (2PCT)

Measurement via 1 A or 5 A current transformer
Item No. 879-3040

Energy meter, direct connection (4PS)

Direct measurement up to 65 A
Item No. 879-3020



Energy meter, direct connection

Direct measurement up to 65 A
Item No. 879-3000



[Learn more](#)

Technical Details

879-3000	879-3020	879-3040
		
Energy meter, direct connection (4PU)	Energy meter, direct connection (4PS)	Energy meter, transformer connection (2PCT)
Direct measurement up to 65 A 2616 Series		Measurement via 1 A or 5 A current transformer 2604 Series
Measurement in 2-, 3- and 4-conductor networks (3 x 230 V / 400 V)		
Configuration via touch-sensitive controls and <i>Bluetooth®</i>		
Interfaces: Modbus®, M-Bus, pulse output, Bluetooth® 2604 Series		
External rate control input (230 V) 2604 Series		
4-quadrant measurement		
Displays: voltage (V), current (A), frequency (Hz), active power (kW), reactive power (kvarh), apparent power (kVA)		
Connection technology with Push-in CAGE-CLAMP® and lever		

Connection possible for conductor types:

Push-in CAGE CLAMP® is the universal connection technology for all conductor types that provides the simplicity of push-in terminations.

WAGO 2616 Series

Solid conductors 0.75 ... 16 mm² / 18 ... 4 AWG
 Fine-stranded conductors 0.75 ... 25 mm² / 18 ... 4 AWG
 Fine-stranded conductors; with ferrule with plastic collar 0.75 ... 16 mm²

WAGO 2604 Series

Solid conductors 2 0.2 ... 4 mm² / 24 ... 12 AWG
 Fine-stranded conductors 2 0.2 ... 4 mm² / 24 ... 12 AWG
 Fine-stranded conductors; with ferrule with plastic collar 0.25 ... 2.5 mm²

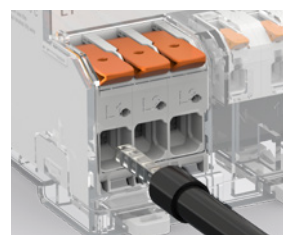

Direct pluggable connection for solid conductors



Lever-based connection for fine-stranded conductors



Direct pluggable connection for conductors with ferrules

Examples of each meter type in a four-wire three-phase network:

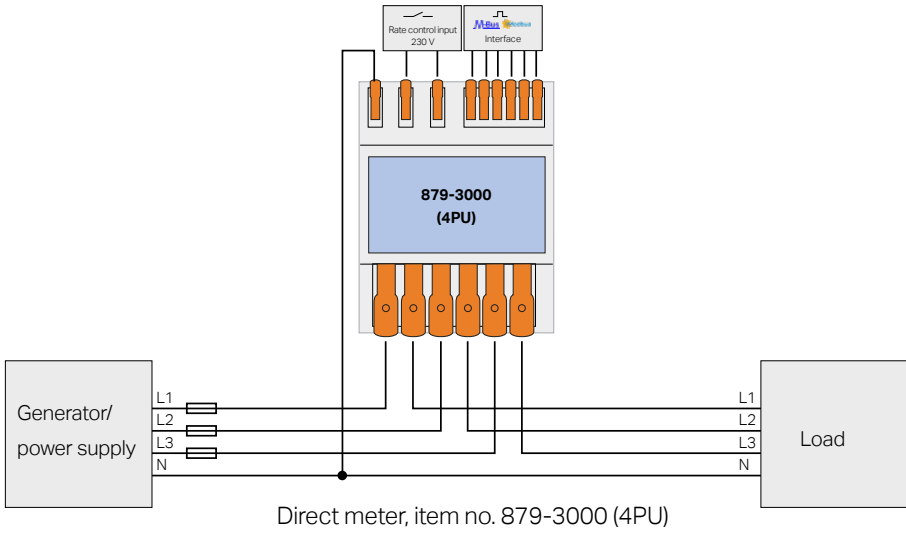

Direct meter, item no. 879-3000 (4PU)

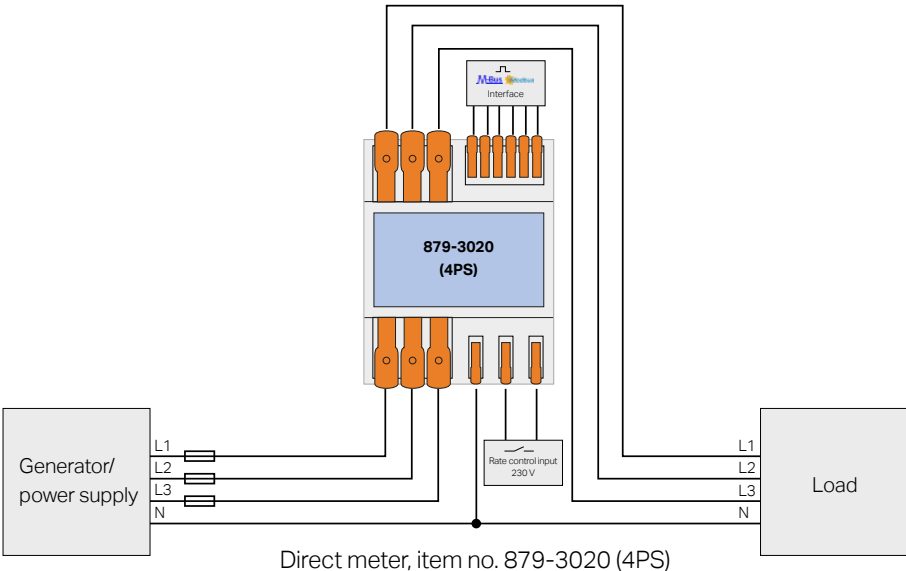

Direct meter, item no. 879-3020 (4PS)

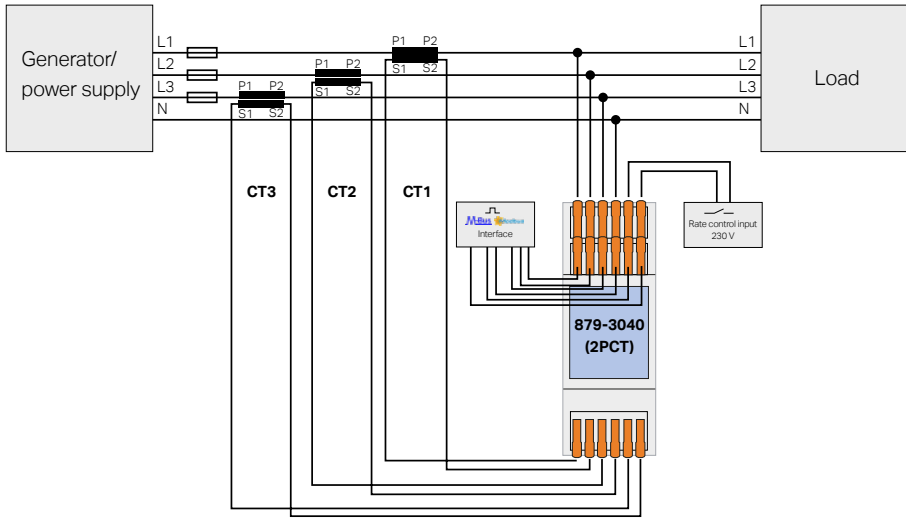

Transformer meter, item no. 879-3040 (2PCT)

WAGO also has MID-compliant billing transformers suitable for use with the energy meter – see page 31.

The DIN-rail-mount enclosure conveniently integrates into your control cabinet:



The MID-compliant energy meters can be used in various sectors that involve billing.

- Charging infrastructure – transparency on wall boxes and charging stations
- Order-based production – measuring the energy consumption of production machinery
- Distributed properties – individually bill each tenant based on usage

Application examples:

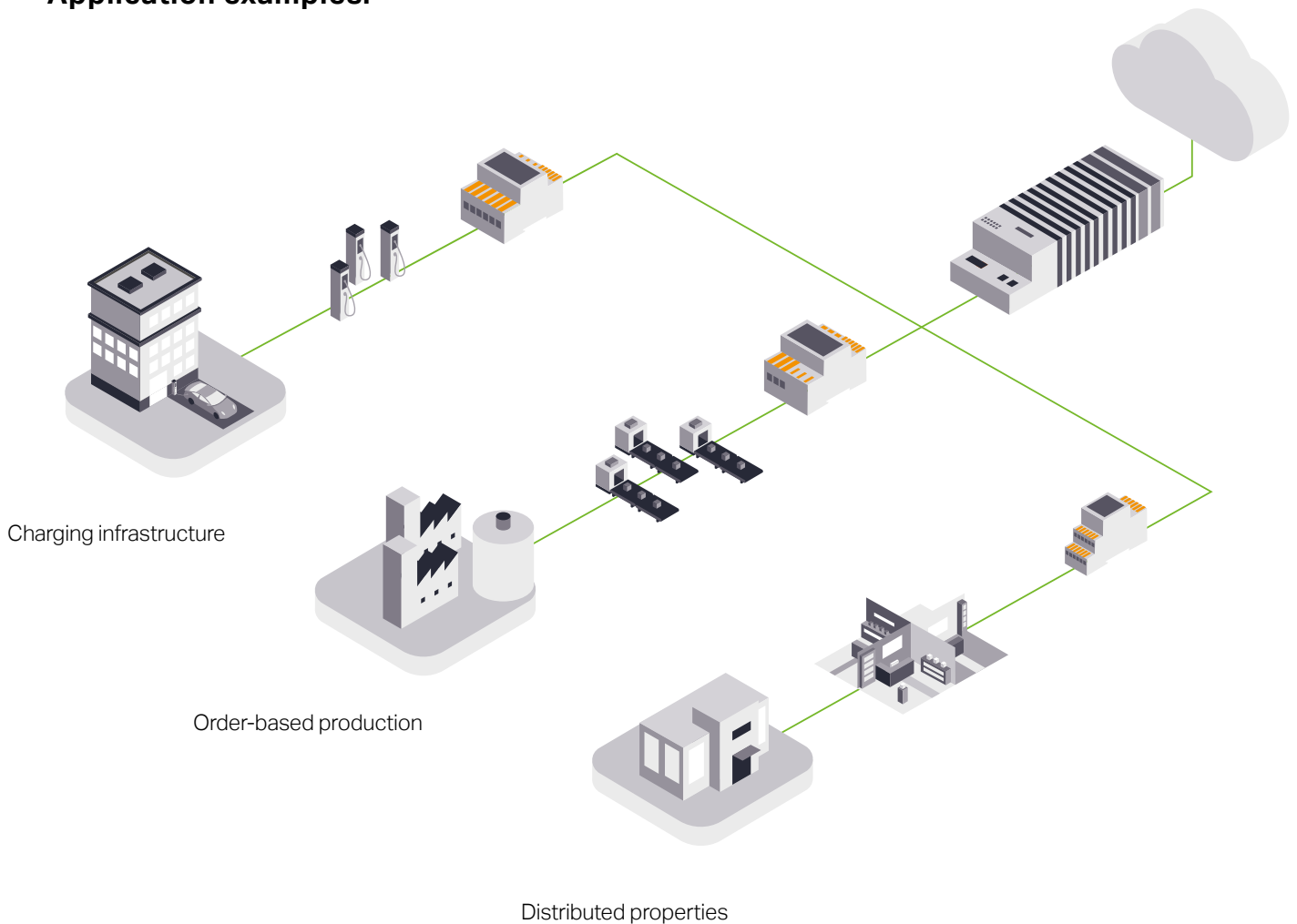

WAGO Power and Energy Measurement

With the WAGO I/O System 750 and 750 XTR

WAGO's 3-Phase Power Measurement Modules measure and process all relevant metrics from a three-phase supply network. They provide system operators with greater

insight into energy consumption by specific machines and systems, as well as the ability to perform comprehensive network analysis.

Your Benefits:

- Measure machine and system energy consumption values
 - Detect and process all relevant metrics
 - Comprehensive network analysis
 - Connection to the fieldbus-independent, compact and flexible WAGO I/O System
- The dark gray modules from the 750 XTR Series can also be used in eXTReme environments and offer these advantages:
 - eXTReme temperatures from -40 to +70 °C
 - eXTReme isolation up to 5 kV of impulse voltage
 - eXTReme vibration resistance up to 5g of acceleration

750 Series Measurement Devices	3-Phase Power Measurement Modules				
Illustration					
Application	Measurement and evaluation with the WAGO I/O System			AC/DC current measurement via external shunt	Measurement in the medium-voltage range
Input voltage	3~ 277 / 480 VAC 2 x 277 VDC	3~ 277 / 480 VAC 2 x 277 VDC	3~ 400 / 690 VAC	3~ 277 / 480 VAC 2 x 277 VDC	3~ 20 kV, exclusively via sensors per IEC 61869-7
Input current	1 A (750-493)* 5 A (750-493/000-001)*	1 A (750-494)* 5 A (750-494/000-001)*	1 A (750-495)* 5 A (750-495/000-001)* to 4000 A (750-495/000-002)**	Depending on external shunt (50 ... 300 mV)	300 A, exclusively via sensors per IEC 61869-8
Output	Process data in the WAGO I/O System				
Other product variants		Extended temperature range: -20 ... +60 °C: 750-494/025-000 (1 A), 750-494/025-001 (5 A)	750 XTR: 750-495/040-000 (1 A), 750-495/040-001 (5 A), 750-495/040-002 (Rogowski Coil)		
Housing width	12 mm	12 mm	24 mm	12 mm	24 mm
Item number	See information on current	See information on current	See information on current	750-494/000-005	750-495/040-010
Note	Plug-in current transformers, split-core current transformers, Rogowski coils, voltage taps – see "Selection Guide: WAGO Current Transformers," pages 24 ... 25				

* Only with a current transformer

** Only with a Rogowski coil

General Configuration

Power and energy measurement of a machine in a 480 VAC mains network with 3-phase power measurement module (750-493, 750-494)

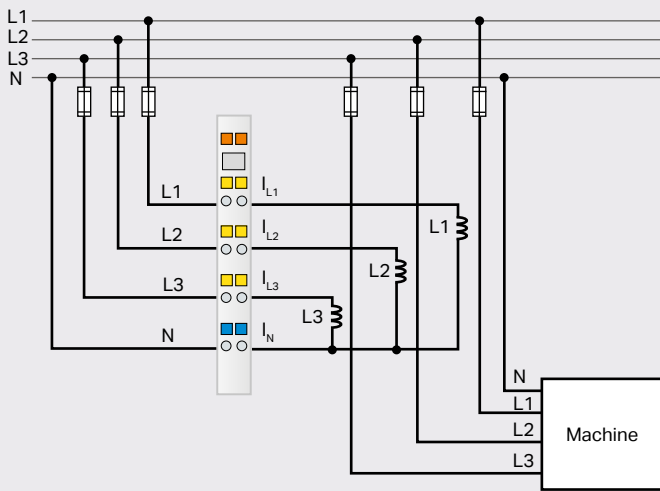

General Configuration

Power, energy and N-conductor measurement of a machine in a 480/690 VAC mains network with 3-phase power measurement module (750-495)

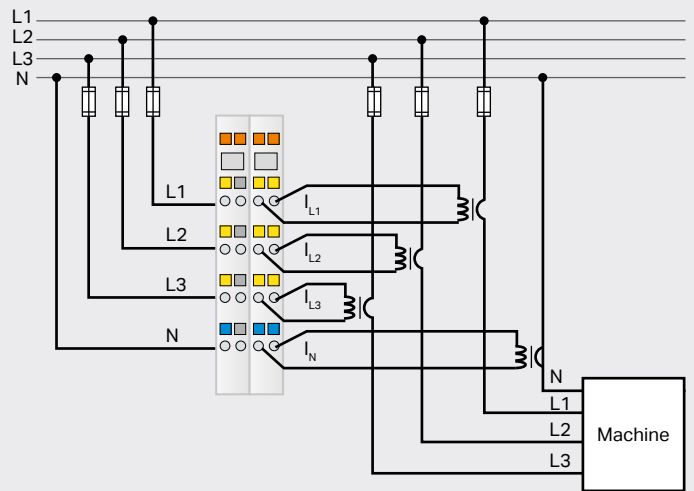

Application

Direct connection of Rogowski coils to the 3-phase power measurement module (750-495/000-002)

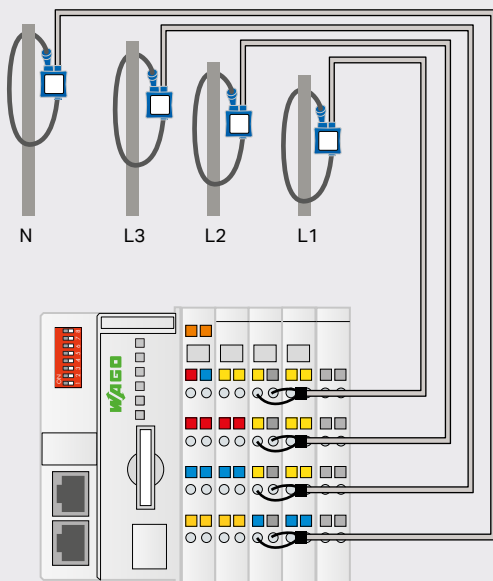

Application

Direct connection of external shunts to the 3-phase power measurement module (750-494/000-005)

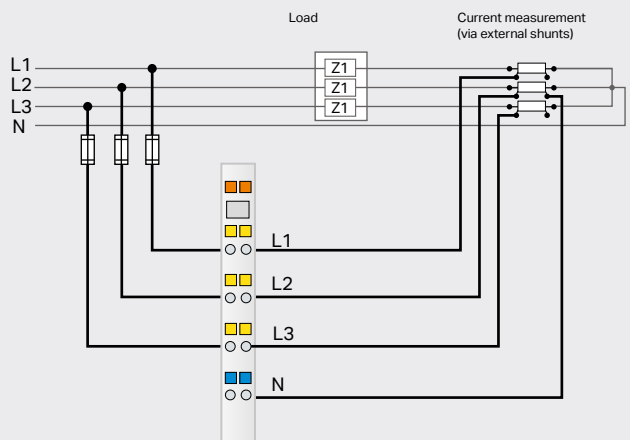

3-Phase Power Measurement Modules, 2857 Series

Measure Electrical Data in Three-Phase Supply Networks

Successful energy management requires knowing the consumption values of machines and systems. With the 3-Phase Power Measurement Module in a DIN-rail-mount enclosure, WAGO offers the ideal solution to measure currents and voltages in a three-phase supply network, remotely from the control level. Measured variables such as active/apparent/reactive power, energy consumption, power factor, phase angle and frequency can be accessed via Modbus® interface. Two integrated RJ45 sockets streamline the interconnection of up to 32 devices. In addition, the 3-phase power measurement module can log the corresponding measured variables on a microSD card. Easy configuration and display of measured variables using WAGO's Interface Configuration software enable the user to perform comprehensive data analysis.

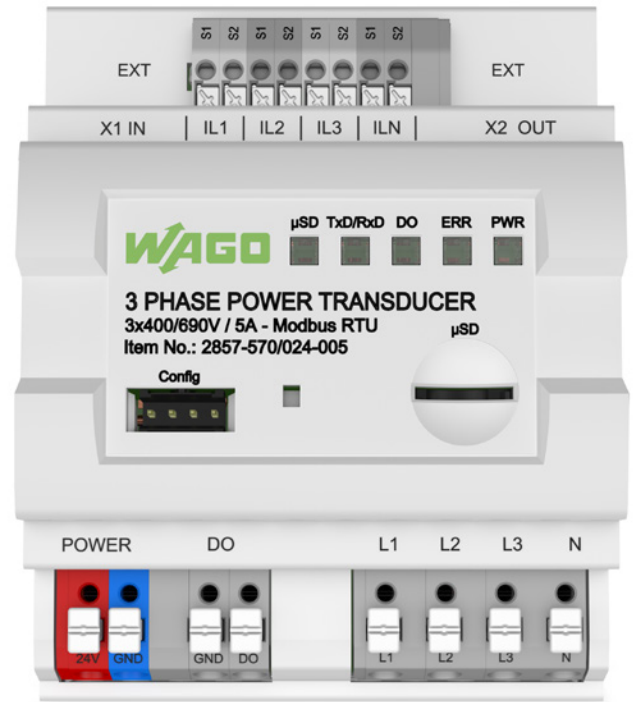

View from above



View from below

Your Benefits:

- **Measurement via current transformers or Rogowski coils:** Flexible selection of upcoming measurement tasks
- **Slot for microSD cards:** Fast and secure mobile measurement, including recording
- **Compact device in DIN-rail-mount enclosure:** Saves space in building technology
- **Modbus® interface (RS-485):** Measured values provided via Modbus®
- **Digital signal output as pulse output (pulses/kWh are configurable):** Continuous energy consumption monitoring

Application Example

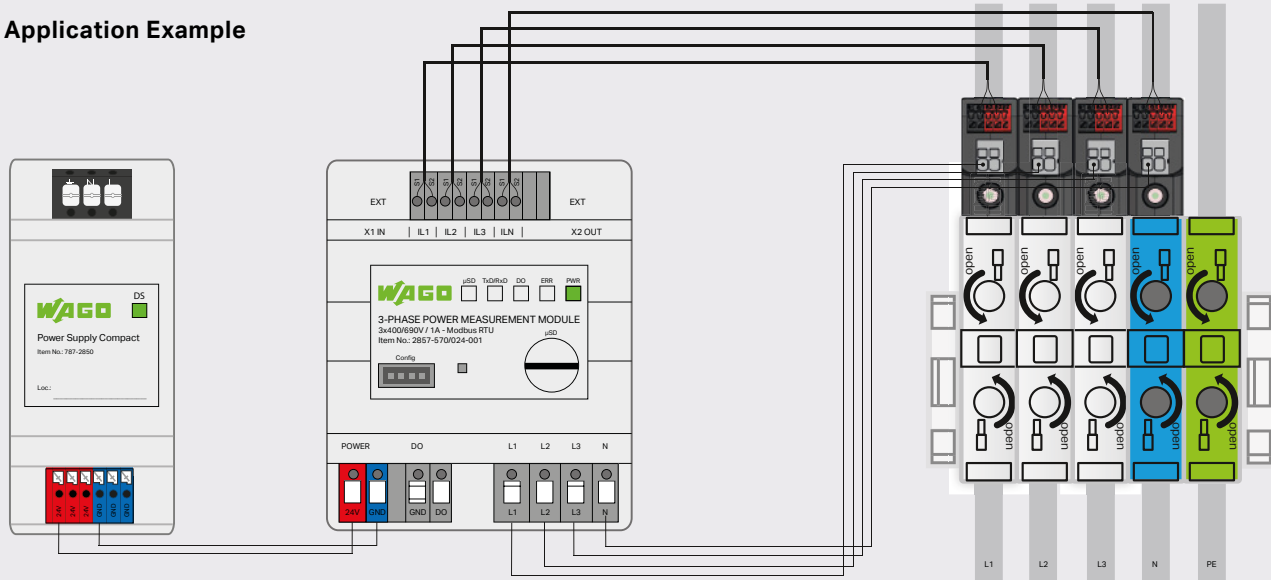

Power Supply,
787-2850

3-Phase Power Measurement Module,
2857-570 / 024-001

Power Supply

Overview of 3-Phase Power Measurement Modules

Item number	2857-570 / 024-001	2857-570 / 024-005	2857-570 / 024-000
Current measurement via	1 A current transformer	5 A current transformer	Rogowski Coils
Protocol/interface	Modbus RTU via RS-485		
Bus coupler connection	2 RJ45 plugs (daisy chain configuration)		
Configuration	Interface Configuration software Function block (CODESYS V2.3 and V3.0)		
Connection types	3- or 4-wire three-phase network		
Rated voltage	ULN = 400 VAC; ULL = 690 VAC › (industry and buildings)		
Measurement error for current and voltage	Max. 0.5 % (of the upper-range value)		
Output, digital	Can be configured as a digital switched output or S0 interface (pulses per kWh)		
Power supply	24 VDC › (Compact Power Supply, 787-2850)		
SD card	microSD slot › stand-alone measurement		
Product/EMC standard	EN 61010-1 / EN 61000-6-2; EN 61000-6-3		

[Learn more](#)



WAGO Current/Voltage Signal Conditioners and Power Measurement Modules

Besides current and voltage signal conditioners which record DC and AC currents and voltages, this impressive range also includes a power measurement module that can measure current and voltage in parallel, convert them to power and output them as an analog standard signal. Additionally, WAGO's signal conditioner for Rogowski coils offers a solution for retrofitting existing systems. It's no longer necessary to disconnect the live conductor.

Your Benefits:

- Signal acquisition of DC and AC voltages up to 300 VAC/VDC using modules that are just 6 mm wide
- AC currents up to 4000 A via Rogowski coil
- Switchable filter function to prevent signal interference
- A digital signal output (DO) reacts to freely configurable measurement range limits (this allows use as a threshold value switch – with activation/deactivation delay).

Application Examples

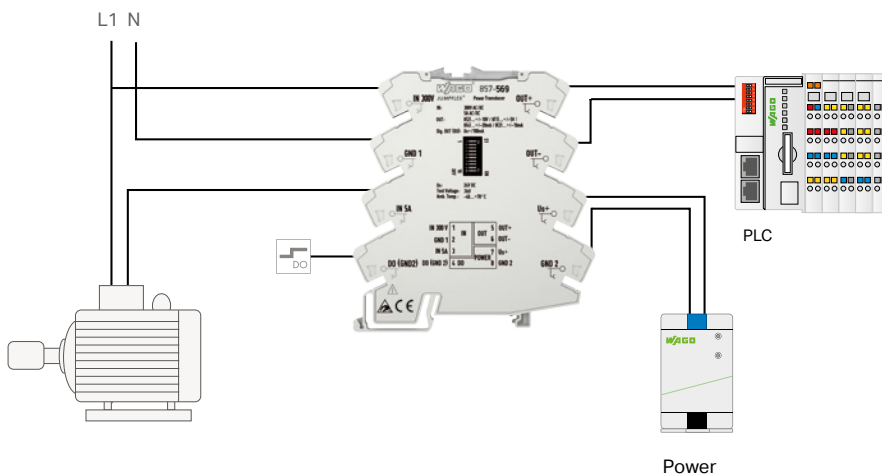

Power Measurement Module, 857-569

Single-phase power measurement

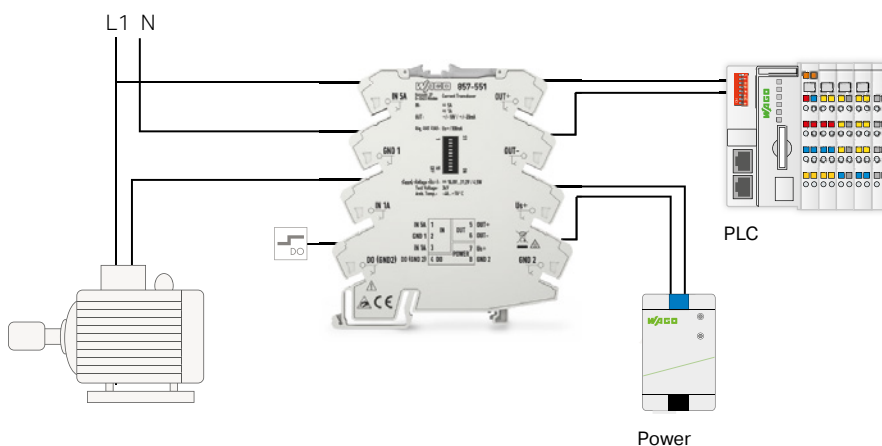

Current Signal Conditioner, 857-551

Current measurement via plug-in current transformer

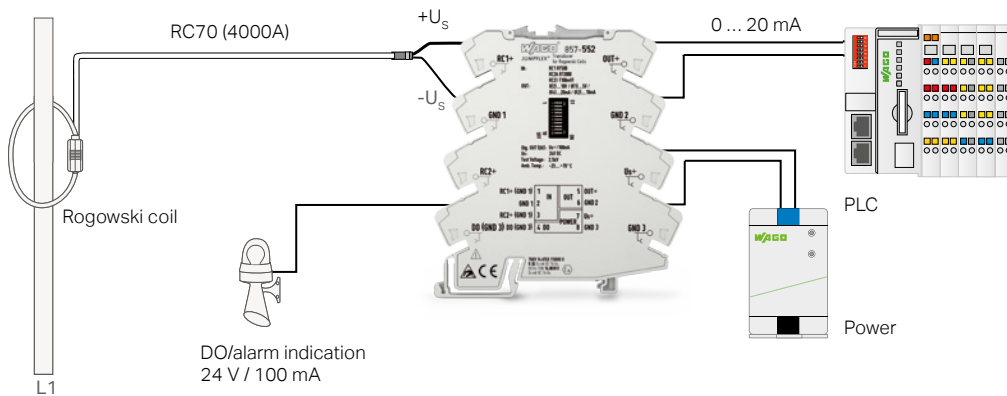

Rogowski Signal Conditioner, 857-552

Current measurement via Rogowski coils

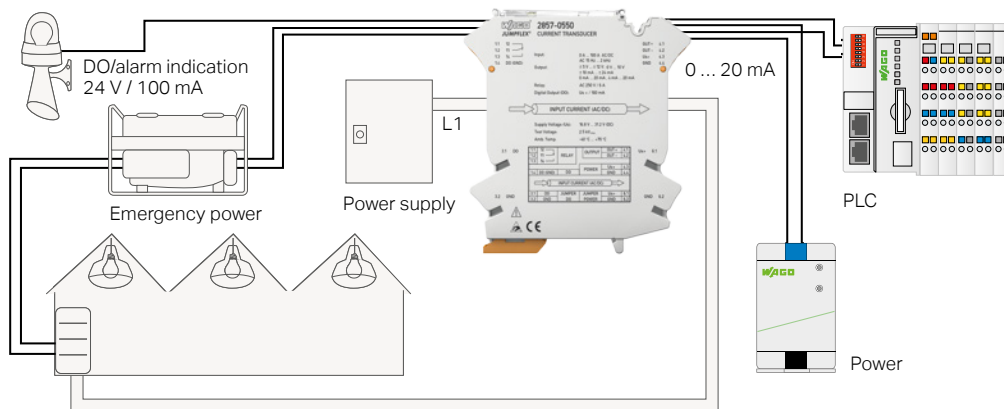

Current Signal Conditioner, 2857-550

Lighting monitoring

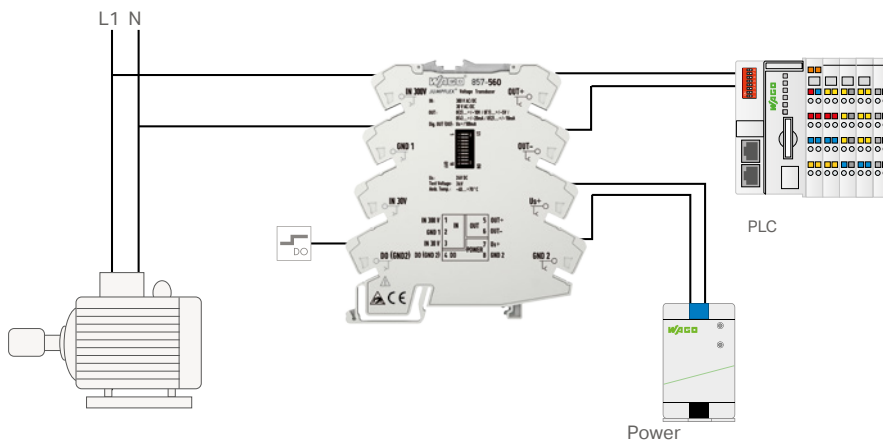















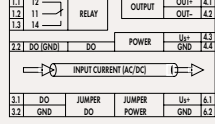

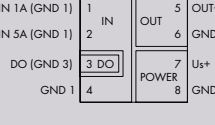

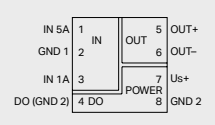

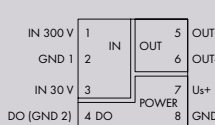

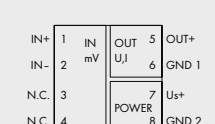







Voltage Signal Conditioner 857-560

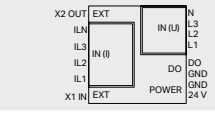

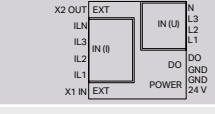
Voltage measurement

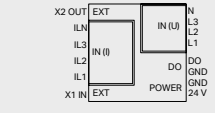

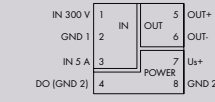

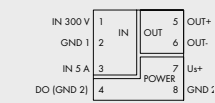





Technical Details

WAGO Current/Voltage Signal Conditioners and Power Measurement Modules

	Description	Illustration	Circuit Diagram	Input			Output	
Current and Voltage Signal Conditioners	 Current and Voltage Signal Conditioners							
	Through-Hole Current Signal Conditioner			AC/DC 100 A			0 ... 10 mA 2 ... 10 mA 0 ... 20 mA 4 ... 20 mA	0 ... 5 V 1 ... 5 V 0 ... 10 V 2 ... 10 V
	Current Signal Conditioner			1 AAC/DC 5 AAC/DC (SELV)			0 ... 10 mA 2 ... 10 mA 0 ... 20 mA 4 ... 20 mA	0 ... 5 V 1 ... 5 V 0 ... 10 V 2 ... 10 V
	Current Signal Conditioner			1 AAC/DC 5 AAC/DC*			0 ... 10 mA 2 ... 10 mA 0 ... 20 mA 4 ... 20 mA	0 ... 5 V 1 ... 5 V 0 ... 10 V 2 ... 10 V
	Voltage Signal Conditioner			300 VAC/DC			0 ... 10 mA 2 ... 10 mA 0 ... 20 mA 4 ... 20 mA	0 ... 5 V 1 ... 5 V 0 ... 10 V 2 ... 10 V
	Millivolt Signal Conditioner				0 ... 200 mV 0 ... 1000 mV	±100 mV	0 ... 10 mA 2 ... 10 mA 0 ... 20 mA 4 ... 20 mA	0 ... 5 V 1 ... 5 V 0 ... 10 V 2 ... 10 V

	Description	Illustration	Circuit Diagram	Input			Output	
Power Measurement Modules	 Power Measurement Modules							
	3-Phase Power Measurement Module; 1 A; Modbus RTU			1 AAC	U_{LN} 400 VAC U_{LL} 690 VAC			
	3-Phase Power Measurement Module; 5 A; Modbus RTU			5 AAC	U_{LN} 400 VAC U_{LL} 690 VAC			
	3-Phase Power Measurement Module; 5 A; Modbus RTU			22.5 mV/kA (Rogowski coil)	U_{LN} 400 VAC U_{LL} 690 VAC			
	Power Measurement Module			300 VAC/DC	5 VAC/DC		±20 mA	±10 V
	Power Measurement Module			8 AAC/DC	500 VAC/DC		±24 mA	±12 V

	Specialty Functions					Configuration				Power Supply	Item No.	EAN No.
												
±12 V ±24 mA	x	x	x	x	x	x	x	x	x	24 VDC	2857-550	4050821676997
	x	x				x	x	x		24 VDC	857-550	4050821226734
±10 V ±20 mA	x	x				x	x			24 VDC	857-551	4050821476917
±10 V ±20 mA	x	x				x	x	x		24 VDC	857-560	4055143481571
		x				x	x	x		24 VDC	857-819	4045454665975

	Specialty Functions					Configuration				Power Supply	Item No.	EAN No.
												
Modbus RTU	x						x			24 VDC	2857-570/024-001	4055143827539
Modbus RTU	x						x			24 VDC	2857-570/024-005	4055143827461
Modbus RTU	x						x			24 VDC	2857-570/024-000	4055143829199
	x	x			x		x	x		24 VDC	857-569	4055143501026
	x	x	x	x			x		x	24 VDC	2857-569	4055143907323

Selection Guide: WAGO Current Transformers

The Right Solution for Every Application

Current Transformers, 855 Series	Split-Core Current Transformers	Plug-In Current Transformers with CAGE CLAMP® Connection Technology
		
Application	Retrofits	New systems
Coil bobbin	Separable	Closed
Connection technology	Connection cable (color coded)	CAGE CLAMP®
Mounting	Round cable (insulated), copper current bar (insulated)	Round cable, copper current bar, DIN-rail, mounting plate
Compatibility with other WAGO components	750-493, (750-493/000-001) 750-494, (750-494/000-001) 750-495, (750-495/000-001) 857-550, 2857-570/024-001 2857-570/024-005	
Primary rated current	60 ... 1000 A	50 ... 2500 A
Secondary rated current	1 A / 5 A	1 A / 5 A
Accuracy class	0.5; 1 or 3	1 or 3
Surrounding air temperature	-10 ... +55 °C	-5 ... 50 °C
Standards	EN 61869-2	EN 61869-2
Approvals	—	
Connection examples		

*In the measurement range between 0.8 and 32 A and in combination with WAGO's 3-Phase Power Measurement Modules, accuracy class 0.5 per EN 6

Plug-In Current Transformers with <i>picoMAX</i> ® Pluggable Connectors		Rogowski Coils RC 70 / RC 125 / RC 175	Current and Voltage Taps
			
New systems		Retrofits	New systems
Closed		Bayonet connector, separable	Closed
<i>picoMAX</i> ®		Connection cable	Push-in CAGE CLAMP®
Round cable, DIN-rail, mounting plate		Round cable, copper current bar	Jumper slot of the 285 Series 2-Conductor Through Terminal Blocks 285-150, 285-195, 285-1185, 285-141, 285-181, 285-1161
750-493, 750-494 750-495, 857-550, 2857-570/024-001		750-495/000-002 857-552 2857-570/024-000	750-493 750-494 750-495 857-550 2857-570/024-001
32 A	35 / 64 A	Up to 4000 A	150 ... 350 A
320 mA	1 A	22.5 mV/kA	1 A
0.5*	1	0,5	0,5
-10 ... +55 °C		-40 ... +80 °C	-25 ... +70 °C
EN 61869-2		IEC 61010-1 / EN 61869-2	EN 61869-2, EN 60947-7-3, IEC 60068-2-6
-		UL listed	-
			

1869-2 is achieved.



WAGO Split-Core Current Transformers

Retrofit Existing Systems

WAGO's Split-Core Current Transformers are ideal for retrofitting existing systems and have the great advantage of working without interrupting the measuring line. These new current transformers measure primary currents of 60 A to 1000 A, as well as secondary currents of 1 A or 5 A. Thanks to a compact and easy-to-open housing, they

can be mounted quickly. If space is limited, their hinge (855-5xxx) can be completely removed. The enclosed cable ties allow the current transformers to be secured easily and economically. They offer color-coded connection cables and meet the requirements of EN 61869-1/EN 61869-2.

Your Benefits:

- Compact and separable split-core current transformers – ideal for retrofitting existing systems
- No current path interruption
- Easy and cost-effective installation via cable ties
- Hinge (855-5xxx) can be completely removed if space is tight



Watch the video
to learn more

Termination – Made Easy



- Compact split-core current transformers – ideal for retrofitting existing systems



- Hinge (855-5xxx) can be completely removed if space is tight
- With color-coded connection cables

Quick and Easy Mounting



- No current path interruption
- Easy and cost-effective installation via cable ties



- Audible click confirms correct installation

Technical Details

WAGO Split-Core Current Transformers

Illustration	Primary Rated Current	Secondary Rated Current	Rated Power	Accuracy Class	Cable Length	Item No.	EAN No.
Ø 18 mm							
	60 A	1 A	0.2 VA	3	3 m	855-3001/060-003	4050821880554
	75 A	1 A	0.2 VA	3	3 m	855-3001/075-003	4055143950565
	100 A	1 A	0.2 VA	3	3 m	855-3001/100-003	4050821880561
	125 A	1 A	0.2 VA	3	3 m	855-3001/125-003	4055143950732
	150 A	1 A	0.2 VA	3	3 m	855-3001/150-003	4055143950589
	200 A	1 A	0.2 VA	1	3 m	855-3001/200-001	4050821880677
	250 A	1 A	0.2 VA	1	3 m	855-3001/250-001	4050821880684
Ø 18 mm							
	100 A	1 A	0.2 VA	1	3 m	855-4001/100-001	4050821880578
	125 A	1 A	0.2 VA	1	3 m	855-4001/125-001	4055143950572
	150 A	1 A	0.2 VA	1	3 m	855-4001/150-001	4050821880585
	200 A	1 A	0.2 VA	0.5	3 m	855-4001/200-001	4050821880592
	250 A	1 A	0.2 VA	0.5	3 m	855-4001/250-000	4055143950442
	150 A	5 A	1 VA	1	0.5 m	855-4005/150-101	4055143056342
	200 A	5 A	1 VA	1	0.5 m	855-4005/200-101	4055143950596
	250 A	5 A	1 VA	0.5	0.5 m	855-4005/250-100	4055143950459
	Ø 28 mm						
	200 A	1 A	0.2 VA	1	3 m	855-4101/200-001	4050821880608
	250 A	1 A	0.2 VA	1	3 m	855-4101/250-001	4050821880615
	300 A	1 A	0.2 VA	1	3 m	855-4101/300-001	4055143950657
	400 A	1 A	0.2 VA	1	3 m	855-4101/400-001	4050821880622
	500 A	1 A	0.2 VA	0.5	3 m	855-4101/500-000	4055143950749
	250 A	5 A	1 VA	1	0.5 m	855-4105/250-101	4055143056359
	300 A	5 A	1 VA	1	0.5 m	855-4105/300-101	4055143950473
	400 A	5 A	1 VA	1	0.5 m	855-4105/400-101	4055143056366
	500 A	5 A	1 VA	1	0.5 m	855-4105/500-101	4055143950466

Illustration	Primary Rated Current	Secondary Rated Current	Rated Power	Accuracy Class	Cable Length	Item No.	EAN No.	
Ø 42 mm								
	250 A	1 A	0.5 VA	1	5 m	855-5001/250-001	4055143163064	
	300 A	1 A	0.5 VA	1	5 m	855-5001/300-001	4055143950756	
	400 A	1 A	0.5 VA	0.5	5 m	855-5001/400-000	4050821880653	
	500 A	1 A	0.5 VA	0.5	5 m	855-5001/500-000	4055143950480	
	600 A	1 A	0.5 VA	0.5	5 m	855-5001/600-000	4050821880646	
	750 A	1 A	0.5 VA	0.5	5 m	855-5001/750-000	4055143950497	
	800 A	1 A	0.5 VA	0.5	5 m	855-5001/800-000	4055143950763	
	1000 A	1 A	0.5 VA	0.5	5 m	855-5001/1000-000	4050821880639	
	300 A	5 A	0.5 VA	1	3 m	855-5005/300-001	4055143950503	
	400 A	5 A	0.5 VA	1	3 m	855-5005/400-001	4055143056373	
	500 A	5 A	0.5 VA	1	3 m	855-5005/500-001	4055143950817	
	600 A	5 A	0.5 VA	0.5	3 m	855-5005/600-000	4055143056380	
	750 A	5 A	0.5 VA	0.5	3 m	855-5005/750-000	4055143950824	
	800 A	5 A	0.5 VA	0.5	3 m	855-5005/800-001	4055143950770	
	1000 A	5 A	0.5 VA	0.5	3 m	855-5005/1000-000	4055143056397	
	2 x Ø 42 mm							
		250 A	1 A	0.5 VA	1	5 m	855-5101/250-001	4055143950602
		300 A	1 A	0.5 VA	1	5 m	855-5101/300-001	4055143950916
		400 A	1 A	0.5 VA	0.5	5 m	855-5101/400-000	4055143950831
500 A		1 A	0.5 VA	0.5	5 m	855-5101/500-000	4055143950664	
600 A		1 A	0.5 VA	0.5	5 m	855-5101/600-000	4055143950923	
750 A		1 A	0.5 VA	0.5	5 m	855-5101/750-000	4055143950787	
800 A		1 A	0.5 VA	0.5	5 m	855-5101/800-000	4055143950930	
1000 A		1 A	0.5 VA	0.5	5 m	855-5101/1000-000	4050821880660	
300 A		5 A	0.5 VA	1	3 m	855-5105/300-001	4055143950671	
400 A		5 A	0.5 VA	1	3 m	855-5105/400-001	4055143950794	
500 A		5 A	0.5 VA	1	3 m	855-5105/500-001	4055143950848	
600 A		5 A	0.5 VA	0.5	3 m	855-5105/600-000	4055143950800	
750 A		5 A	0.5 VA	0.5	3 m	855-5105/750-000	4055143950947	
800 A		5 A	0.5 VA	0.5	3 m	855-5105/800-000	4055143950855	
1000 A		5 A	0.5 VA	0.5	3 m	855-5105/1000-000	4055143056403	

WAGO Plug-In Current Transformers and Plug-in current transformers for billing purposes

With CAGE CLAMP® Connection Technology



Your Benefits:

- Screwless CAGE CLAMP® connection technology
- Primary currents from 50 to 2500 A / secondary currents of 1 A or 5 A
- Continuous overload of 120% the nominal primary current
- Tool-free installation via quick-mount kit
- Low-voltage current transformer for max. operating voltages up to 1.2 kV
- UL certified (Certificate No. E356480)
- EN 61869-1 / EN 61869-2



Inserting a conductor



CAGE CLAMP® connection



Watch the video to
learn more

Time-Saving Installation with Plug-In Current Transformers from WAGO



Quick-Mount Kit, 855-9910

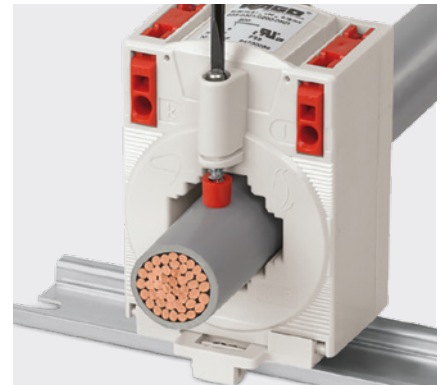

Mounting on round cable



Mounting on DIN-rail
via DIN-rail adapter



Installation on mounting plate

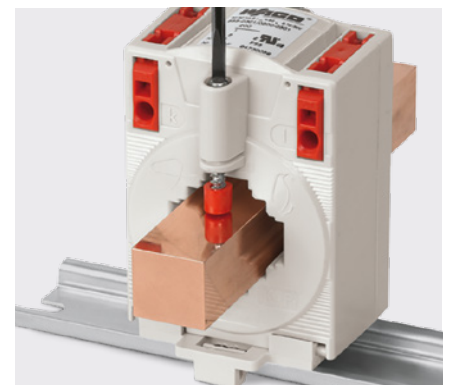

Mounting on copper current bar

The Ideal Addition:

WAGO Plug-in current transformers for billing purposes
energy meters with a transformer connection

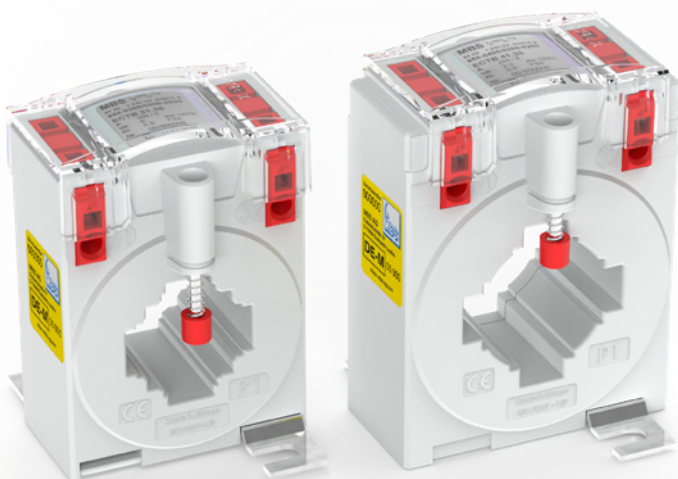

Your Benefits:

- The new current transformers have been approved through the conformity assessment process for use in billing third parties
- The perfect combination with the transformer meters in WAGO's energy meter product group (item no. 879-3040)
- Screwless wiring with CAGE CLAMP® connection technology

Variants/Sizes:

Item No.: 855-0305/0100-0209

Item No.: 855-0405/0100-0209

WAGO Plug-In Current Transformers

With CAGE CLAMP® Connection Technology

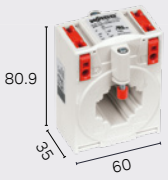



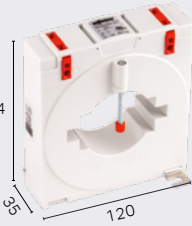

Illustration	Primary Rated Current	Secondary Rated Current	Rated Power	Accuracy Class	Item No.	EAN No.
 <p>80.9 60 35</p> <p>Busbar 1: 30 x 10 mm Busbar 2: 25 x 12 mm Busbar 3: 20 x 20 mm Round cable: 26 mm</p>	50 A	1 A	1.25 VA	3	855-301/050-103	4050821614654
	50 A	5 A	1.25 VA	3	855-305/050-103	4050821749301
	60 A	1 A	1.25 VA	1	855-301/060-101	4050821616856
	60 A	5 A	1.25 VA	1	855-305/060-101	4050821749318
	75 A	1 A	2.5 VA	1	855-301/075-201	4050821616863
	75 A	5 A	2.5 VA	1	855-305/075-201	4050821749325
	100 A	1 A	2.5 VA	1	855-301/100-201	4050821616870
	100 A	5 A	2.5 VA	1	855-305/100-201	4050821749332
	150 A	1 A	5 VA	1	855-301/150-501	4050821616887
	150 A	5 A	5 VA	1	855-305/150-501	4050821749349
	200 A	1 A	5 VA	1	855-301/200-501	4050821616894
	200 A	5 A	5 VA	1	855-305/200-501	4050821749356
	250 A	1 A	5 VA	1	855-301/250-501	4050821616900
	250 A	5 A	5 VA	1	855-305/250-501	4050821616900
	300 A	5 A	5 VA	1	855-305/300-501	4055143389174
	400 A	1 A	10 VA	1	855-301/400-1001	4050821616917
	400 A	5 A	10 VA	1	855-305/400-1001	4050821749387
	600 A	1 A	10 VA	1	855-301/600-1001	4050821616924
600 A	5 A	10 VA	1	855-305/600-1001	4050821749400	
 <p>91.15 70 35</p> <p>Busbar 1: 40 x 10 mm Busbar 2: 30 x 15 mm Round cable: 32 mm</p>	250 A	1 A	5 VA	1	855-401/250-501	4055143523226
	250 A	5 A	5 VA	1	855-405/250-501	4050821845706
	400 A	1 A	5 VA	1	855-401/400-501	4050821616931
	400 A	5 A	5 VA	1	855-405/400-501	4050821749370
	600 A	1 A	5 VA	1	855-401/600-501	4055143262521
	750 A	5 A	5 VA	1	855-405/750-501	4055143389181
 <p>105.25 85 35</p> <p>Busbar 1: 50 x 12 mm Busbar 2: 40 x 30 mm Round cable: 44 mm</p>	400 A	1 A	10 VA	1	855-501/400-1001	4055143523233
	400 A	5 A	10 VA	1	855-505/400-1001	4050821845881
	600 A	1 A	10 VA	1	855-501/600-1001	4055143523240
	600 A	5 A	10 VA	1	855-505/600-1001	4050821845737
	800 A	1 A	10 VA	1	855-501/800-1001	4055143523257
	800 A	5 A	10 VA	1	855-505/800-1001	4050821845744
	1000 A	1 A	10 VA	1	855-501/1000-1001	4050821616948
	1000 A	5 A	10 VA	1	855-505/1000-1001	4050821749417
 <p>114.85 95 35</p> <p>Busbar 1: 63 x 10 mm Busbar 2: 50 x 30 mm Round cable: 44 mm</p>	1500 A	1 A	5 VA	1	855-601/1500-501	4055143262538
	1500 A	5 A	5 VA	1	855-605/1500-501	4055143263009

Illustration	Primary Rated Current	Secondary Rated Current	Rated Power	Accuracy Class	Item No.	EAN No.	
 <p>Busbar 1: 80 x 10 mm Busbar 2: 60 x 30 mm Round cable: 55 mm</p>	1000 A	1 A	10 VA	1	855-801/1000-1001	4055143523264	
	2000 A	1 A	10 VA	1	855-801/2000-1001	4055143262996	
	2000 A	5 A	10 VA	1	855-805/2000-1001	4055143262989	
 <p>Busbar 1: 100 x 10 mm Busbar 2: 80 x 30 mm Round cable: 70 mm</p>	2500 A	1 A	10 VA	1	855-1001/2500-1001	4055143262972	
	2500 A	5 A	10 VA	1	855-1005/2500-1001	4055143262965	

WAGO Plug-in current transformers for billing purposes

Illustration	Primary Rated Current	Secondary Rated Current	Rated Power	Accuracy Class	Item No.	EAN No.
 <p>Busbar 1: 30 x 10 mm Busbar 2: 25 x 12 mm Busbar 3: 20 x 20 mm Round cable: 26 mm</p>	100 A	5 A	2.5 VA	0.5	855-305/100-209	4055144041439
	150 A	5 A	2.5 VA	0.5	855-305/150-209	4055144041446
	200 A	5 A	5 VA	0.5	855-305/200-509	4055144041453
	250 A	5 A	5 VA	0.5	855-305/250-509	4055144041293
	300 A	5 A	5 VA	0.5	855-305/300-509	4055144041460
	400 A	5 A	5 VA	0.5	855-305/400-509	4055144041309
	500 A	5 A	5 VA	0.5	855-305/500-509	4055144041514
	600 A	5 A	5 VA	0.5	855-305/600-509	4055144041378
	750 A	5 A	5 VA	0.5	855-305/750-509	4055144041613
 <p>Busbar 1: 40 x 10 mm Busbar 2: 30 x 15 mm Round cable: 32 mm</p>	200 A	5 A	2.5 VA	0.5	855-405/200-209	4055144041521
	250 A	5 A	2.5 VA	0.5	855-405/250-209	4055144041484
	300 A	5 A	5 VA	0.5	855-405/300-509	4055144041620
	400 A	5 A	5 VA	0.5	855-405/400-509	4055144041385
	500 A	5 A	5 VA	0.5	855-405/500-509	4055144041392
	600 A	5 A	5 VA	0.5	855-405/600-509	4055144041538
	750 A	5 A	5 VA	0.5	855-405/750-509	4055144041637
Accessories					Item No.	EAN No.
	DIN-Rail Adapter for Plug-In Current Transformers (for 855-3xx/xxxx-xxxx and 855-4xx/xxxx-xxxx)				855-9900	4050821627593
	Quick-Mount Kit (2 pieces, including cable tie)				855-9910	4050821749981

WAGO Plug-In Current Transformers

With *picoMAX*® Pluggable Connector

With 1 A Output

Your Benefits:

- Convert 35 A or 64 A to 1 A
- Accuracy class 1 per EN 61869-2
- Mount on DIN-rail or mounting plates via DIN-rail adapter
- UL certified (Certificate No. E356480)
- EN 61869-1 / EN 61869-2



Watch the video to learn more



Mounting



Just snap together



Use adapter to snap to DIN-rail



As a space-saving option, mount directly above the circuit breaker

Conductor Termination



Push-in termination of solid conductors and fine-stranded conductors with ferrules



Universal connection for fine-stranded conductors

Illustration	Primary Rated Current	Secondary Rated Current	Rated Power	Accuracy Class	Conductor Feed-through	Item No.	EAN No.
	35 A	1 A	0.2 VA	1	Ø 7.5 mm	855-2701/035-001	4050821864240
	64 A	1 A	0.2 VA	1	Ø 7.5 mm	855-2701/064-001	4050821864189
	DIN-rail adapter					855-9927	4050821866381

With Low Power Output

Your Benefits:

- The first transformer with a lower power output
- Specifically designed for converting low currents from 32 A to 320 mA
- Complies with accuracy class 0.5 per EN 61869-2 in the measurement range of 0.8 to 32 A and in combination with the 3-Phase Power Measurement Module



Watch the video
to learn more

Mounting



Just slide together



Side-by-side assembly



To save space, mount directly above circuit breaker

Conductor Termination



Push-in termination of solid conductors and fine-stranded conductors with ferrules



Universal connection for fine-stranded conductors

Illustration	Primary Rated Current	Secondary Rated Current	Rated Power	Accuracy Class	Conductor Feed-through	Item No.	EAN No.
	32 A*	320 mA	0.1 Ω	0.5**	Ø 5.0 mm	855-1700/ 032-000	4055143333436

*Measurement range: 0.8 to 32 A in combination with the 3-Phase Power Measurement Modules (750-493/-94/-495)

**Testing adheres to EN 61869-2 with a conversion ratio of 16 A/0.16 A (accuracy class: 0.5) and an extended primary current of 200%.

WAGO Rogowski Coils

For Quickly and Easily Retrofitting Existing Systems



Your Benefits:

- Rated insulation voltage: 1000 V Cat. III / 600 V Cat. IV
- Accuracy class 1 per EN 61869-2
- Protection type: IP65
- Surrounding air temperature: -40 ... +80 °C
- UL certified



Watch the video to learn more



Illustration	Description	Cable Length	Feedthrough for Measurement Conductor
	RC-070 Rogowski Coil	1.5 m	Ø 70 mm
		4.5 m	
	RC-125 Rogowski Coil	1.5 m	Ø 125 mm
		4.5 m	
	RC-175 Rogowski Coil	1.5 m	Ø 175 mm
		4.5 m	

* The specifications for the primary rated current apply when combined with select WAGO modules (857-552, 750-495/000-002 and 2857-570/000-000). Rogowski technology allows the coils to measure a wide primary current range of up to 10,000 A without loss of accuracy, because there are no saturation effects with this technology



Bayonet connector:
Robust and durable



Fixing lugs:
Quick and easy mounting with cable ties



Lock-out seal:
Greater security with sealable bayonet lock

Easy to Use:

- Rogowski coil diameter: 70, 125 or 175 mm
- Length of signal line: 1.5 m or 4.5 m
- Sealable bayonet connector
- Anchor points for cable ties

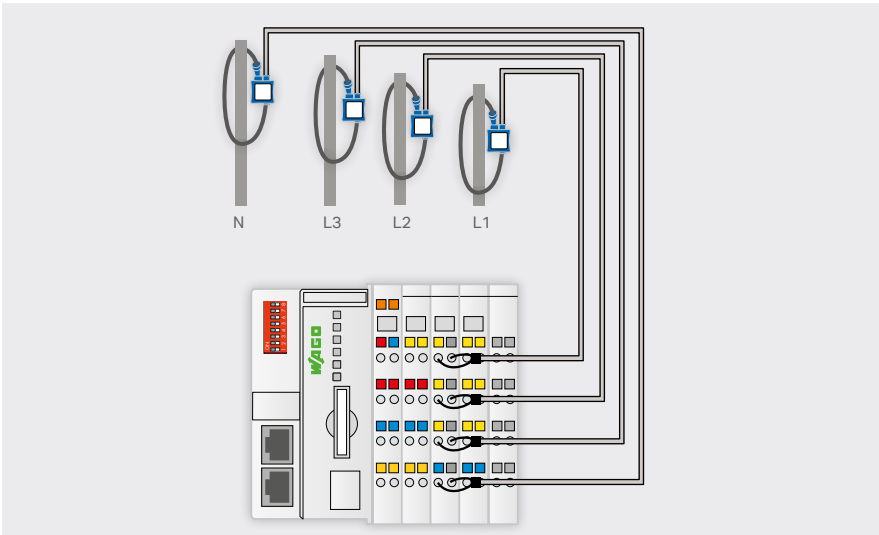

Direct connection of Rogowski coils to the 3-Phase Power Measurement Module (750-495/000-002 or 2857-570/000-001)



Primary Rated Current*	Output Signal	Accuracy Class**	Item No.	EAN No.
4000 AAC	22.5 mV/kA at 50 Hz	0.5	855-9150/2000-0701	4055143419185
			855-9450/2000-0701	4055143419239
4000 AAC	22.5 mV/kA at 50 Hz	0.5	855-9150/2000-1251	4055143419208
			855-9450/2000-1251	4055143419215
4000 AAC	22.5 mV/kA at 50 Hz	0.5	855-9150/2000-1751	4055143419192
			855-9450/2000-1751	4055143419222

** Per EN 61869-2

WAGO Current and Voltage Taps

The 2-in-1 Solution

Combining a current transformer and voltage tap, this ingenious solution can be quickly and easily mounted in the jumper slot of WAGO's 2-Conductor Through Terminal Blocks (285 Series). This combination is the perfect basis for any successful energy management plan.

Your Benefits:

- Same overall width as 2-conductor through terminal blocks
- Easy installation – simply insert the tap into the jumper slot of the 2-conductor through terminal blocks
- Current transformer can be short circuited via S1 and S2 using a jumper (2000-402)
- Safe protection in case of overload and short circuit via integrated fuse with indicator
- Clear identification via WAGO's marking options

Output – Voltage

- Redundant design

Output – Current

- Connecting the energy measurement device (1 A)
- Short-circuiting the current transformer
- Star point jumper

Marking Options

- TOPJOB® S Marking Strips
- WMB Inline Markers

Feedthrough for Primary Conductors



[Watch the video to learn more](#)

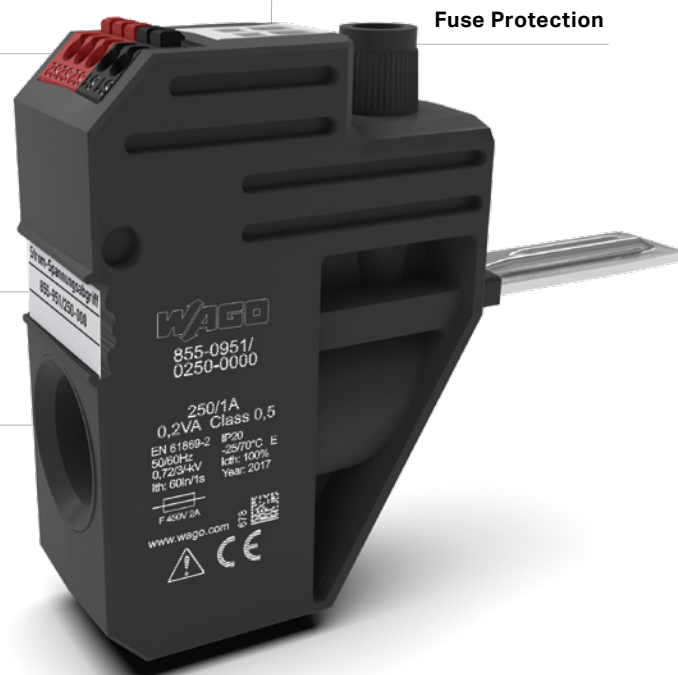

Fuse Protection



Feedthrough for primary conductors

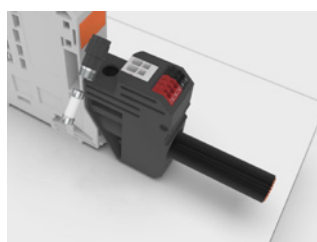

Integrated fuse

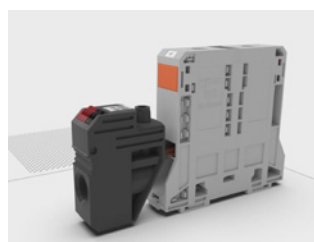

Installation via jumper slot



Marking option

Technical Data

Product			
			
Item number	855-0501 / 150-000	855-0951 / 250-000	855-1851 / 350-000
Feedthrough for measurement conductor	∅ 12.0 mm	∅ 16.0 mm	∅ 21.5 mm
Primary rated current I_{pri}	150 A	250 A	350 A
Secondary rated current I_{sec}	1 A		
Accuracy class	0.5 (per EN 61869-2)		
Rated power	0.2 VA (8.0 m cable length for conductors up to 1.5 mm ² /16 AWG)		
Rated voltage	400 VAC		
Fuse (voltage path)	F2 A, 450 V, 70 kA, 5 x 25 mm		
Operating temperature	-25 ... +70 °C		
Product standard	EN 61869-2, EN 60947-7-3, IEC 60068-2-6		
Suitable for 2-conductor through terminal blocks	50 mm ² (1/0 AWG)	95 mm ² (4/0 AWG)	185 mm ² (350 kcmil)
For DIN-rail mounting	285-150	285-195	285-1185
	285-154	285-194	285-1184
With mounting flanges	285-141	285-181	285-1161
	285-144	285-184	285-1164

Accessories		Item No.	EAN No.
	Spare miniature fuse with indicator 2 A, 450 V, F, 70 kA (5 x 25 mm)	855-8020	4055143981712

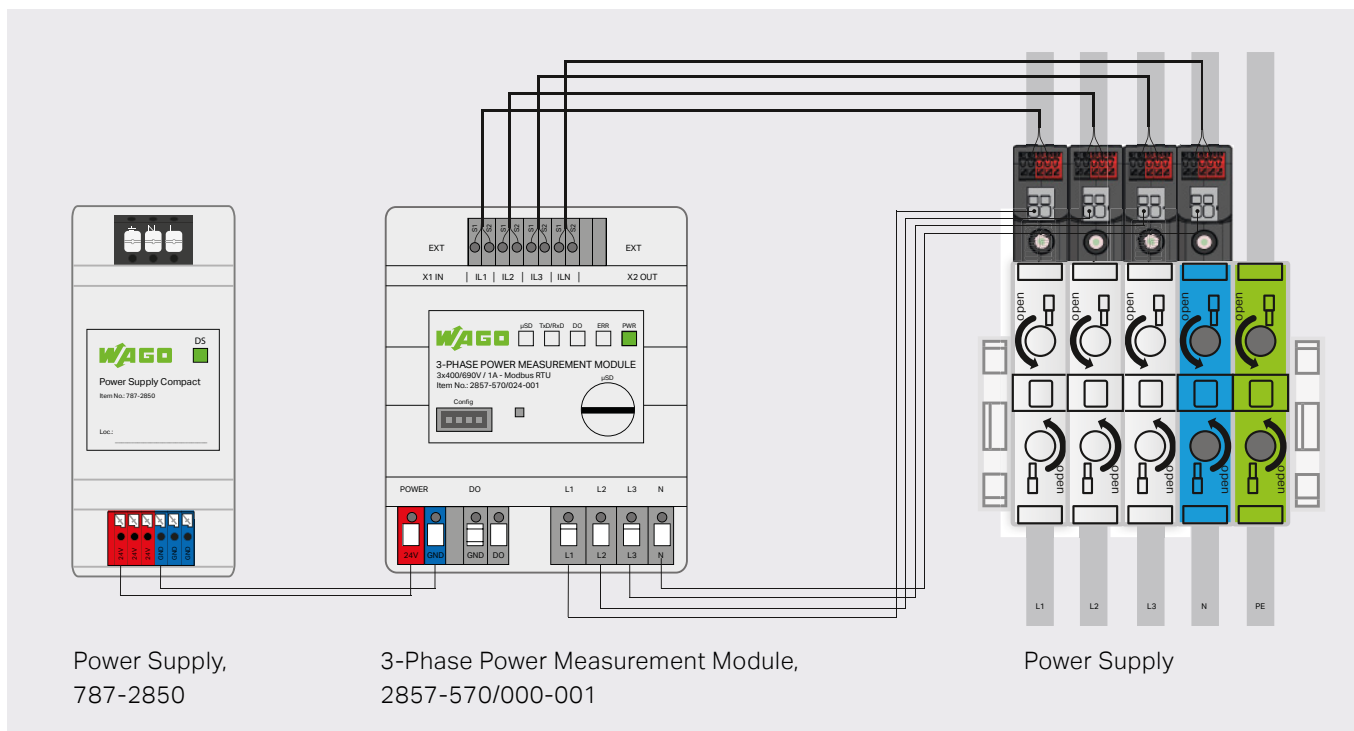

Application Example: The Complete Retrofit Solution

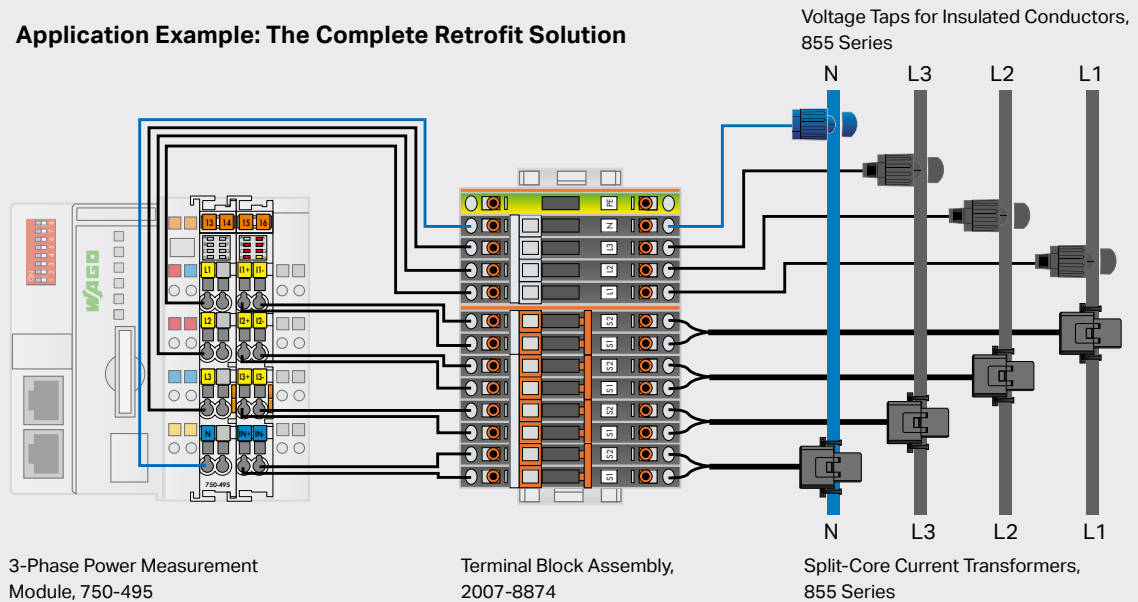

WAGO Voltage Taps

For Insulated Conductors



Installation on insulated conductor with IDC connection



Integrated SIBA fuse to protect equipment and conductor

Your Benefits:

- Faster measurement voltage tapping in no time
- Tool-free assembly
- Conductor contact via IDC connection
- Integrated SIBA fuse reliably protects the measurement device and conductor



Watch the video to learn more

Illustration	Conductor Cross-Section	Fuse	Cable Length	Mounting	Item No.	EAN No.
	2.5 ... 6 mm ² Ø 3 ... 5 mm (feedthrough for measurement conductor)	2 A, 450 V, F, 70 kA (5 x 25 mm)	3 m (pre-assembled)	Conductor contact via IDC connection	855-8001	4055143371780
		–			855-8002	4055143378857
	10 ... 16 mm ² (8–6 AWG) Ø 5 ... 7 mm (feedthrough for measurement conductor)	2 A, 450 V, F, 70 kA (5 x 25 mm)			855-8003	4055143371797
		–			855-8004	4055143378840

Accessories		Item No.	EAN No.
	Spare miniature fuse with indicator 2 A, 450 V, F, 70 kA (5 x 25 mm)	855-8020	4055143981712

Application Example: The Complete Retrofit Solution

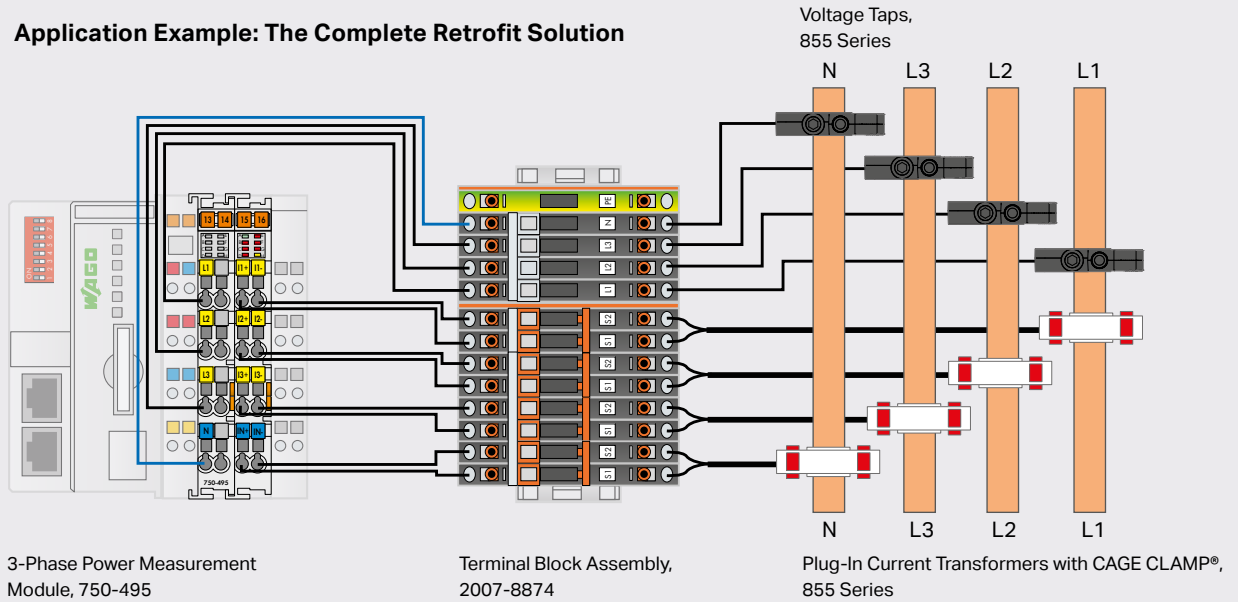

For Busbars



Installation on busbar; fastening with Allen wrench



Integrated SIBA fuse (overload and short circuit protection)

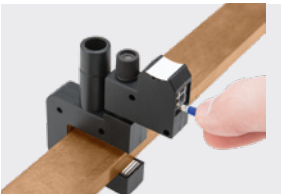

Push-in CAGE CLAMP® connection technology



Various marking options for clear identification

Your Benefits:

- Fast, easy installation on a live busbar with clamp mount or M6/M8 mount
- Marking options for clear identification
- Universal conductor termination via Push-in CAGE CLAMP® connection technology
- Fused voltage path protects downstream measurement devices



Watch the video to learn more

Illustration	Fuse	Connection Technology Solid/Fine-Stranded	Mounting	Item No.	EAN No.
			M6 mount	855-8006	4055143720038
	2 A, 450 V, F, 70 kA (5 x 25 mm)	Push-in CAGE CLAMP® (WAGO 2624 Series)	M8 mount	855-8008	4055143720052
			Clamp mount (4 ... 15 mm bar thickness)	855-8015	4055143720076
	T-wrench			855-8000	–

Accessories		Item No.	EAN No.
	Spare miniature fuse with indicator 2 A, 450 V, F, 70 kA (5 x 25 mm)	855-8020	4055143981712



iStock.com/AvatarKnowmad

Line Length Calculation for WAGO Current Transformers

The Sophisticated Solution for Your System Planning

To determine actual power requirements, both those of the connected measurement devices and the power losses from the measurement lines connected to a transformer's secondary circuit must be accounted for. The WAGO Interface Configuration Software quickly and easily calculates cable lengths and provides the results for your system documentation.

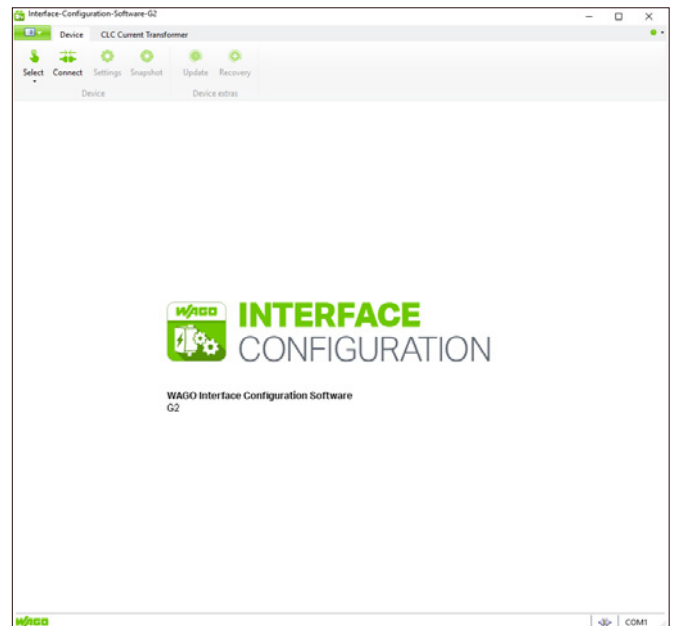

Start screen of the WAGO Interface Configuration Software

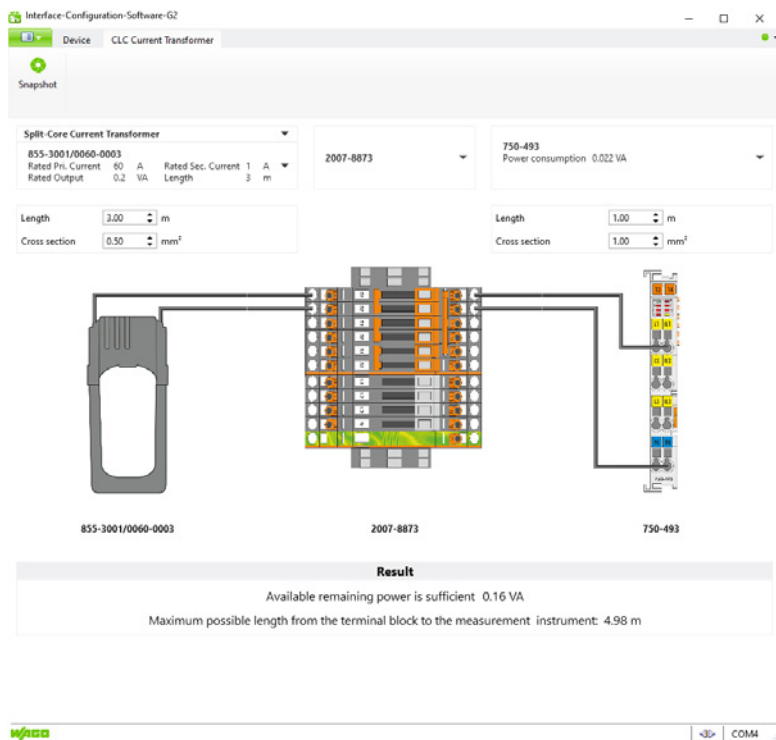

11.05.2020 07:32 WAGO Kontakttechnik GmbH & Co. KG	
Interface Configuration Software(1.0.4.1)	
Current Transformer	
Order number	855-3001/0060-0003
Rated Pri. Current	80 A
Rated Sec. Current	1 A
Rated Output	0.414 VA
Measurement instrument	
Order number	750-493
Power consumption	0.022 VA
Cabel from transducer to terminal block	
Length	3 m
Cross section	0.5 mm ²
Power loss	0.214 VA
Cabel from transducer to measurment instrument	
Length	1 m
Cross section	1 mm ²
Power loss	0.036 VA
Result	
Available power	0.414 VA
Total power loss	0.250 VA
Remaining power	0.164 VA
Required power	0.022 VA
Result	Available remaining power is sufficient

Cable length calculation
with the WAGO Interface Configuration Software

Simplify documentation!

Cable length calculation of connecting cables between the measuring instrument and the current transformer

$$P_V = \frac{I_s^2 \times 2 \times L}{A \times K} \text{ VA}$$

I_s = secondary rated current strength [A]
 L = simple cable length in m
 A = cable cross-section in mm²
 P_V = power loss of connection cables
 K = Specific electrical conductivity of the material
the connecting cable in m/Ohm x mm²

Note: When a common three-phase return line is used, the values for P_V are halved!

Current transformer, 5 A

$$P_V = \frac{5^2 \times 2 \times 10}{1.5 \times 56} = 5.96 \text{ VA}$$

Current transformer 1 A

$$P_V = \frac{1^2 \times 2 \times 10}{1.5 \times 56} \text{ VA} = 0.24 \text{ VA}$$

Example:

A 1 A or 5 A current transformer is used, with an ammeter on the secondary circuit, with 10 m between the transformer and the measurement device. Operating equipment is connected to a copper cable (K=56).

Free software download at:

www.wago.com/configuration-software

Terminal Block Assemblies for WAGO Current Transformers and WAGO Voltage Taps

With *picoMAX*® Pluggable Connector

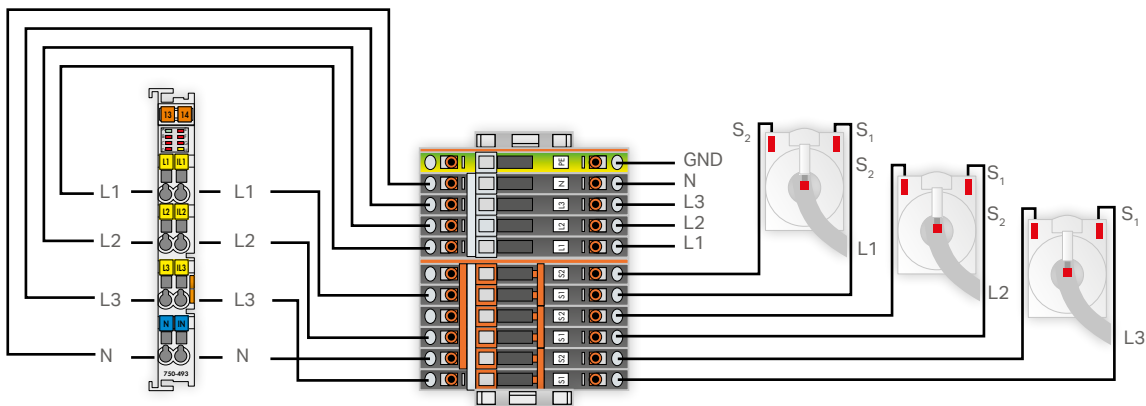

3-Phase Power Measurement Module,
750 Series

Terminal block assembly (2007 Series)
for current transformers and voltage taps

Current Transformers,
855 Series

Suitable for 1 A (750-493), 5 A (750-493/000-001) 1 A (750-494), 5 A (750-494/000-001)

Pre-assembled terminal block assembly for easily connecting and short-circuiting current transformers, suitable for 3-Power Measurement Modules (750-493 and 750-494)

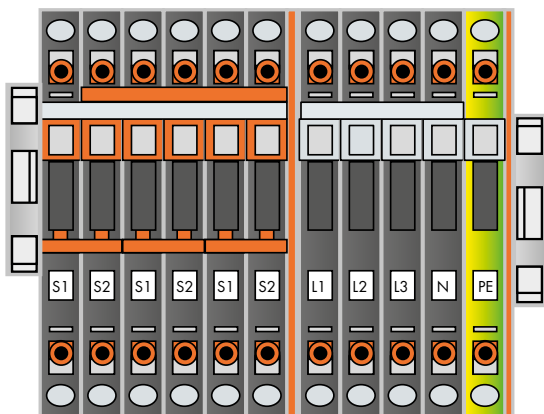

Compact Terminal Block for Current Transformer Circuit, 2007-8873
Connection option for current and voltage, including star point jumper

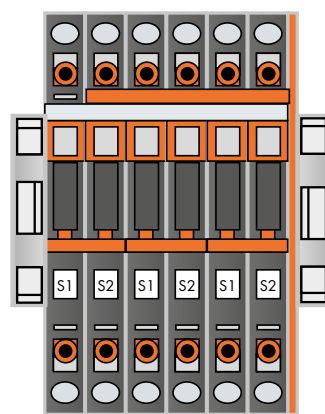

Compact Terminal Block for Current Transformer Circuit, 2007-8875
Connection option for current and voltage, including star point jumper



Watch the video to learn more

Your Benefits:

- Star point jumper
- Easy and clear wiring
- Short-circuiting of current transformers
- Test sockets for control measurements
- Visible current and voltage path separation

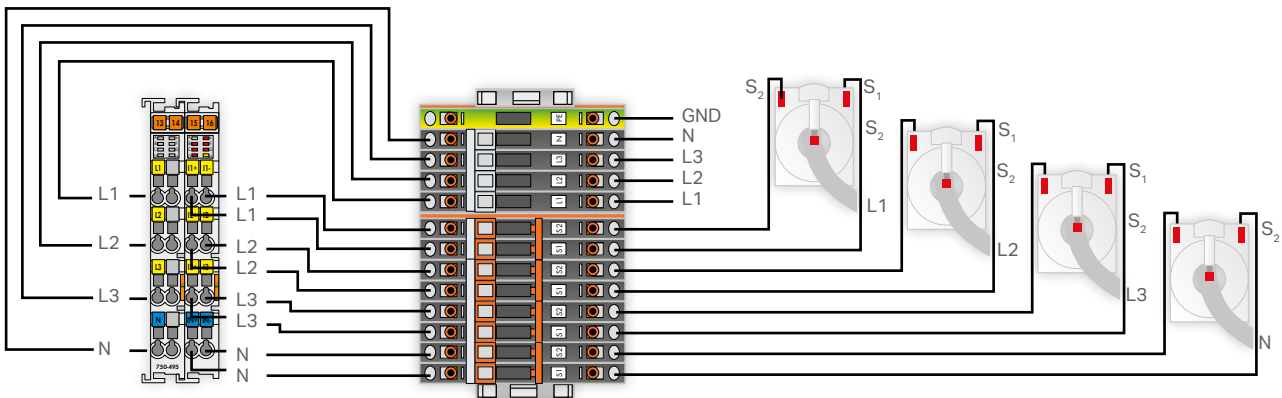

3-Phase Power Measurement Module, 750 Series
Alternative: 2857-570 3-Phase Power Measurement Module

Terminal block assembly (2007 Series) for current transformers and voltage taps

Current Transformers, 855 Series

**Suitable for 1 A (750-495), 5 A (750-495/000-001)
1 A (2857-570/024-001), 5 A (2857-570/024-005)**

Pre-assembled terminal block assembly for easily connecting and short-circuiting current transformers; suitable for 3-Phase Power Measurement Modules (750-495, 2857-570/000-001 and 2857-570/000-005)

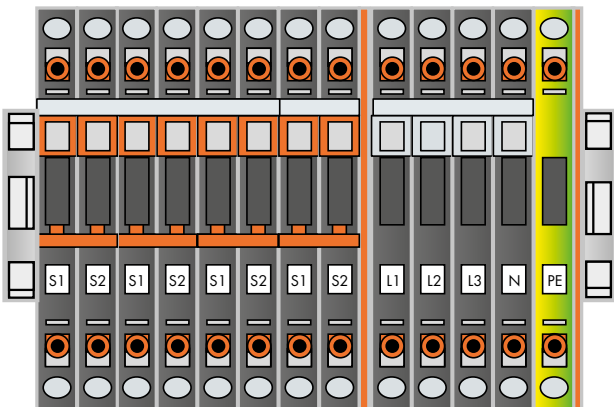

Compact Terminal Block for Current Transformer Circuit, 2007-8874
Connection option for current and voltage

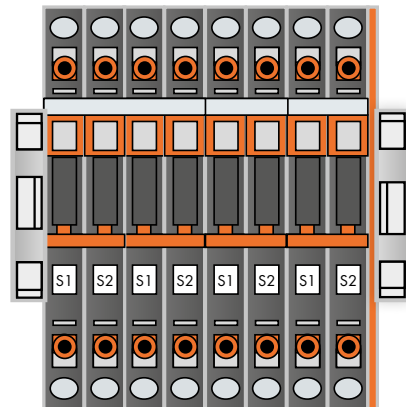

Compact terminal block for current transformer circuit, 2007-8877
Connection option for current



© elxeneize/Fotolia.com

Intelligent Current Sensors

For Monitoring Solar Plants via Modbus Communication

Your Benefits:

- Wide measurement range for measuring AC and DC currents
- Measure line and sum currents for perfect system monitoring
- Easily feed a live conductor through current sensor
- Quickly mount to DIN-rail
- UL certified

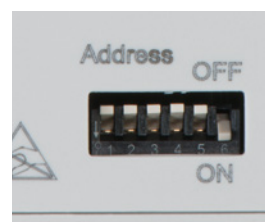
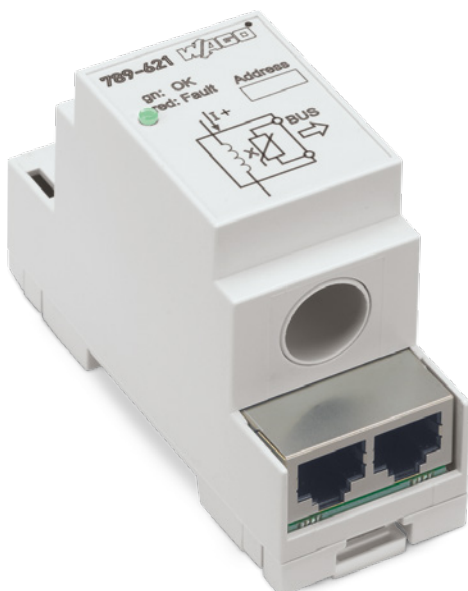



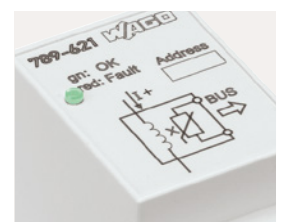

Addressing

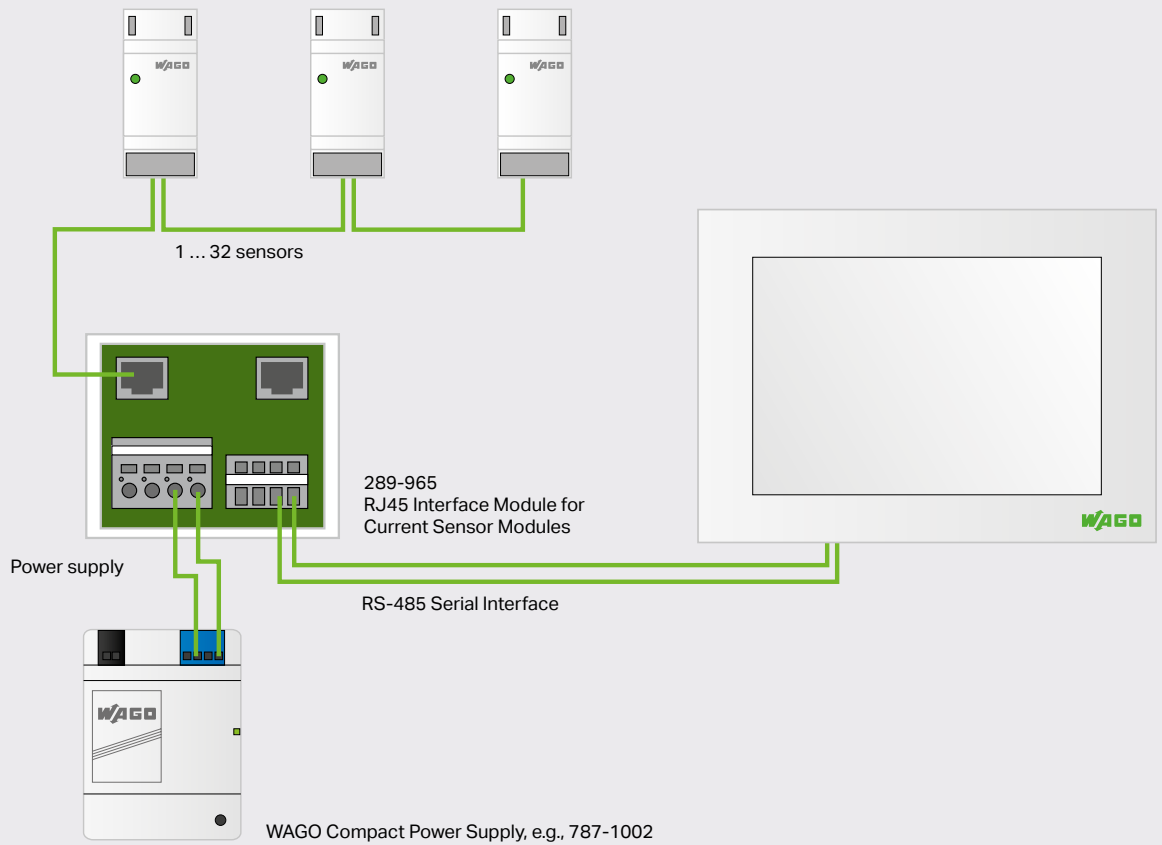

Status indicator

Connection to a Control Panel



			
Measurement range	0 ... 80 ADC	0 ... 140 ADC	0 ... 50 A _{rms} AC
Transmission error	≤ 0.5 % of upper-range value	≤ 0.5 % of upper-range value	≤ 0.5 % of upper-range value
Power supply	12 ... 34 V (via RJ45)	12 ... 34 V (via RJ45)	12 ... 34 V (via RJ45)
Feedthrough	15 mm (for power cable)	15 mm (for power cable)	15 mm (for power cable)
Interface	RS-485	RS-485	RS-485
Protocol	MODBUS over serial line	MODBUS over serial line	MODBUS over serial line
Addressing	1 ... 32	1 ... 32	1 ... 32
Max. length of bus line	≤ 1200 m	≤ 1200 m	≤ 1200 m
Item number	789-620	789-621	789-622

You can find more information on current and energy measurement technology in the FAQ here:



WAGO Kontakttechnik GmbH & Co. KG

Postfach 2880 · D-32385 Minden
Hansastraße 27 · D-32423 Minden

info@wago.com
www.wago.com

Headquarters	+49 (0)571/ 887 - 0
Sales	+49 (0)571/ 887 - 44 222
Orders	+49 (0)571/ 887 - 44 333
Fax:	+49 (0)571/ 887 - 844 169

WAGO is a registered trademark of WAGO Verwaltungsgesellschaft mbH.

“Copyright – WAGO Kontakttechnik GmbH & Co. KG – All rights reserved. The content and structure of the WAGO websites, catalogs, videos and other WAGO media are subject to copyright. Distribution or modification of the contents of these pages and videos is prohibited. Furthermore, the content may neither be copied nor made available to third parties for commercial purposes. Also subject to copyright are the images and videos that were made available to WAGO Kontakttechnik GmbH & Co. KG by third parties.”